

Low Consumption d.c. Operated Contactors

AL Contactors

NL Contactor Relays

IndustrialIT
enabled™

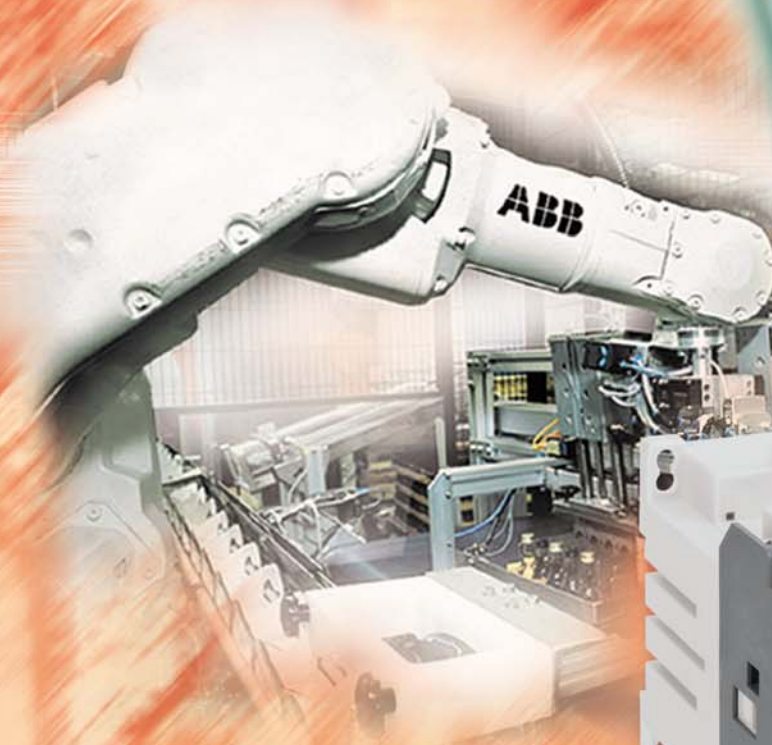

ABB



AL 9 ... AL 40 Contactors NL.. Contactor Relays

d.c. Operated

Contents

Ordering details

3-pole Contactors

– AL.. screw and spring terminals	5
– AL..Z.. screw and spring terminals, 2.4 W	6
– TAL.. screw and spring terminals, large coil voltage range	7

4-pole Contactors

– AL.. and TAL..	8
------------------------	---

Contactor Relays

– NL.. screw and spring terminals	31
– NL Z.. screw and spring terminals, 2.4 W	31
– TNL.. screw and spring terminals, large coil voltage range	32

Technical Data

– AL., AL..Z.. and TAL.. screw and spring terminals	17
– NL., NL Z.. and TNL.. screw and spring terminals	37

Terminal Marking and Positioning

– AL., AL..Z.. and TAL.. 3-pole	43
– AL.. and TAL.. 4-pole	43
– AL..ST and AL..Z..ST	44
– NL.. and NL Z..	45
– NL..ST and NL Z..ST	46

Dimensions

– AL 9 ... AL 16, AL..Z., TAL 9 ... TAL 16, NL., NL Z.. and TNL..	47
– AL 26, TAL 26	49
– AL 30, AL 40, TAL 30 and TAL 40	51
– AL..ST, AL..Z..ST, NL..ST and NL Z..ST	53

AL 9 ... AL 40 Contactors

d.c. Coil - Low Consumption



Power rating AC-3, 400 V

Rated current AC-3, 220-240 V A
380-400 V A
 Rated current AC-1, 40 °C A
 Rated power 220-240 V hp
 3-phase motor 440-480 V hp
 Rated current General use A

3-pole

IEC

UL/CSA



Type (State coil voltage)

Coil consumption, pull-in and holding at 20°C W

	4 kW	5.5 kW	7.5 kW	11 kW	15 kW	18.5 kW
	AL 9	AL 12	AL 16	AL 26	AL 30	AL 40
Rated current AC-3, 220-240 V	9	12	17	26	33	40
Rated current AC-3, 380-400 V	9	12	17	26	32	37
Rated current AC-1, 40 °C	25	27	30	45	55	60
Rated power 220-240 V	2	3	5	10	10	15
3-phase motor 440-480 V	5	7.5	10	20	25	30
Rated current General use	21	25	30	40	50	60
Type (State coil voltage)	AL 9-30-10	AL 12-30-10	AL 16-30-10	AL 26-30-10	AL 30-30-10	AL 40-30-10
Coil consumption, pull-in and holding at 20°C	3	3	3	3.5	3.5	3.5

O/L relays

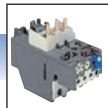

TA 25 DU	0.4 ...0.63	2.2...3.1	7.5 ...11	TA 42 DU
0.10...0.16	1.0 ...1.4	3.5...5.0	13 ...19	22...32
0.16...0.25	1.3 ...1.8	4.5...6.5	18 ...25	29...42
0.25...0.4	1.7 ...2.4	6.0...8.5	24 ...32	

Auxiliary contacts

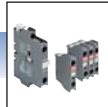

Front mounting 1 N.O. CA 5-10 1 N.C. CA 5-01 4-pole CA 5
 Side mounting 1 N.O. + 1 N.C. CAL 5-11

Timers



Electronic TE5S

Interlocks



Mechanical VM 5-1 / Electrical VE 5-1

Surge suppressors



Varistor RV5
 Transil Diode RT5



Rated current AC-1, 40 °C

Rated current General use

IEC

UL/CSA

4-pole



Type (State coil voltage)

	25 A	30 A	45 A
Rated current AC-1, 40 °C	25 A	30 A	45 A
Rated current General use	21 A	30 A	40 A
	AL 9	AL 16	AL 26
Type (State coil voltage)	AL 9-40-00	AL 16-40-00	AL 26-40-00

AL..., AL...Z..., TAL... 3-pole Contactors



d.c. Operated

Screw Terminals 

Application

AL..., AL...Z..., TAL... contactors are mainly used for controlling 3-phase motors and more generally for controlling power circuits up to 690 V a.c. or 220 / 440 V d.c. These contactors have a low power consumption for direct control from PLC outputs. Consequently they are perfectly adapted for all applications associated with PLC control.

Description

The **AL...** series 3-pole contactors are of the block type design.

The **AL...Z...** series 3-pole contactors are of the block type design with a very low coil consumption of 2.4 W.

The **TAL...** series 3-pole contactors are of the block type design with a large coil voltage range.

- Main poles and auxiliary contact blocks
 - AL 9 ... AL 40 1-stack contactors:**
 - 3 main poles,
 - 1 built-in auxiliary contact,
 - front or side mounted add-on auxiliary contact blocks.
 - AL 9 ... AL 40 2-stack contactors:**
 - 1st stack with 3 main poles,
 - 2nd stack with 4 built-in auxiliary contacts.
- The built-in auxiliary contact elements are mechanically linked
- Control circuit: d.c. operated with solid core magnet circuit and low consumption coil. The coil must be energised from a d.c. supply and the polarity (+ and -) must be respected.
- Accessories: a wide range of accessories are available.

Variants

- 4-pole: AL 9 ... AL 26 contactors (with 4 N.O. or 2 N.O. + 2 N.C. main poles).
- AL 9..ST to AL 16..ST with spring terminals (see page 4).

Contactor designation explanation

- 1) **AL 9Z-30-10**
 - ↙ Z = Version 2.4 W
- 2) **TAL 9-30-10**
 - ↙ T = Large voltage range

Blue = Standard contactor features

Black = Different variations according to the application

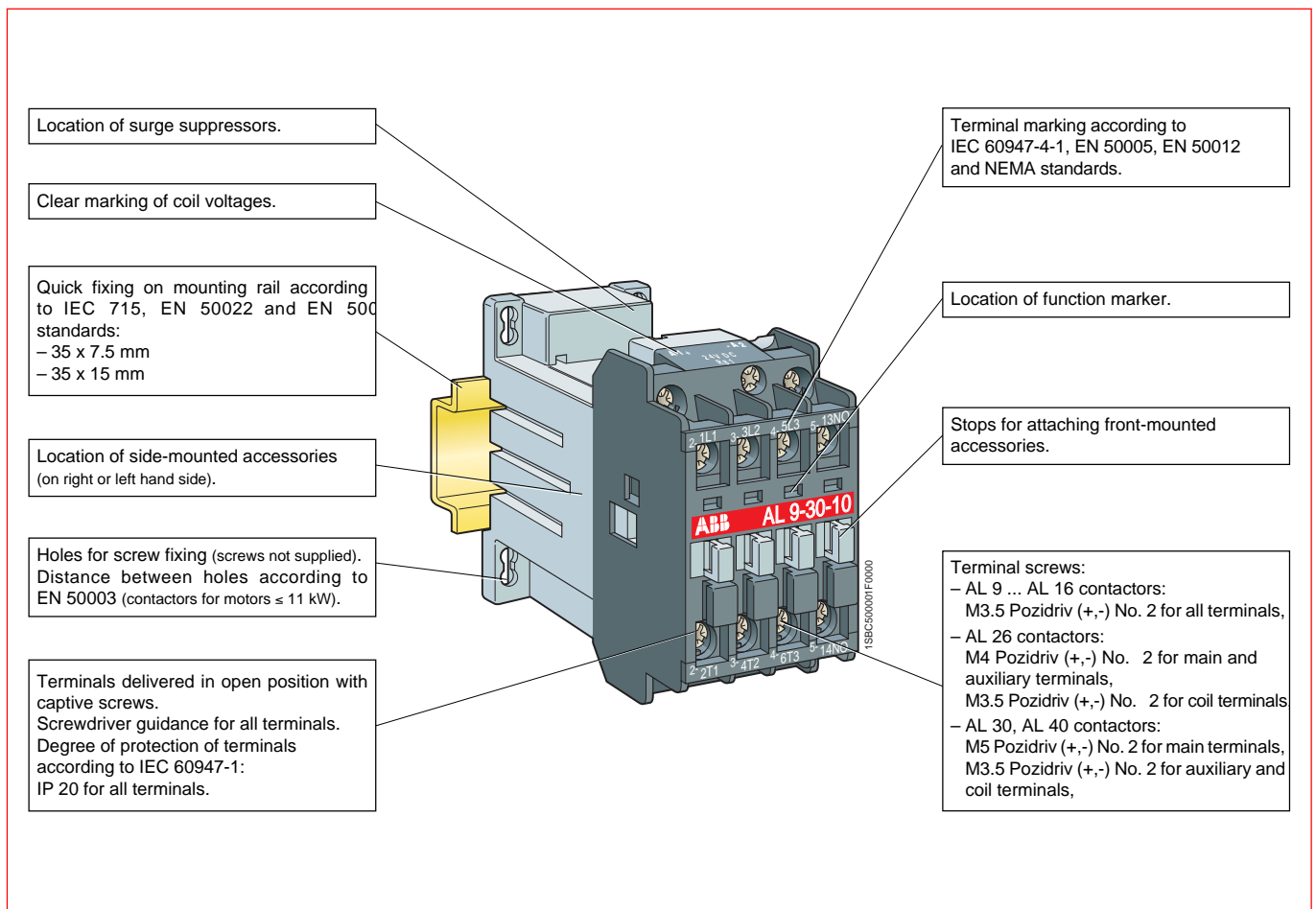

AL.. and AL..ST 3-pole Contactors



d.c. Operated



AL 16-30-10

1SBC87824F0301



AL 40-30-10

1SBC87834F0301



AL 16-30-00ST

1SBC888913F0304

Ordering Details

3-pole Contactors - 3 W and 3.5 W consumption with screw terminals



IEC Rated current AC-3 380V 400V AC-1 415V $\theta \leq 40^\circ\text{C}$ A A	UL		Aux contacts fitted		Type	Order code	Weight kg
	Rated power motor hp	Rated current General use A	1 st stk	2 nd stk			
					state coil voltage <input type="text"/> (see table below)	state coil voltage code <input type="text"/> <input type="text"/> (see table below)	Pack ^{ing} 1 piece
9	25	5	21	1 - - - - 1 - - - - 2 2	AL 9-30-10 <input type="text"/> AL 9-30-01 <input type="text"/> AL 9-30-22 <input type="text"/>	1SBL 14 3001 R <input type="text"/> <input type="text"/> 10 1SBL 14 3001 R <input type="text"/> <input type="text"/> 01 1SBL 14 3001 R <input type="text"/> <input type="text"/> 22	0.520 0.520 0.580
12	27	7.5	25	1 - - - - 1 - - - - 2 2	AL 12-30-10 <input type="text"/> AL 12-30-01 <input type="text"/> AL 12-30-22 <input type="text"/>	1SBL 16 3001 R <input type="text"/> <input type="text"/> 10 1SBL 16 3001 R <input type="text"/> <input type="text"/> 01 1SBL 16 3001 R <input type="text"/> <input type="text"/> 22	0.520 0.520 0.580
17	30	10	30	1 - - - - 1 - - - - 2 2	AL 16-30-10 <input type="text"/> AL 16-30-01 <input type="text"/> AL 16-30-22 <input type="text"/>	1SBL 18 3001 R <input type="text"/> <input type="text"/> 10 1SBL 18 3001 R <input type="text"/> <input type="text"/> 01 1SBL 18 3001 R <input type="text"/> <input type="text"/> 22	0.520 0.520 0.580
26	45	20	40	1 - - - - 1 - - - - 2 2	AL 26-30-10 <input type="text"/> AL 26-30-01 <input type="text"/> AL 26-30-22 <input type="text"/>	1SBL 24 3001 R <input type="text"/> <input type="text"/> 10 1SBL 24 3001 R <input type="text"/> <input type="text"/> 01 1SBL 24 3001 R <input type="text"/> <input type="text"/> 22	0.750 0.750 0.810
32	55	25	50	1 - - - - 1 - - - - 2 2	AL 30-30-10 <input type="text"/> AL 30-30-01 <input type="text"/> AL 30-30-22 <input type="text"/>	1SBL 28 3001 R <input type="text"/> <input type="text"/> 10 1SBL 28 3001 R <input type="text"/> <input type="text"/> 01 1SBL 28 3001 R <input type="text"/> <input type="text"/> 22	0.750 0.750 0.810
37	60	30	60	1 - - - - 1 - - - - 2 2	AL 40-30-10 <input type="text"/> AL 40-30-01 <input type="text"/> AL 40-30-22 <input type="text"/>	1SBL 32 3001 R <input type="text"/> <input type="text"/> 10 1SBL 32 3001 R <input type="text"/> <input type="text"/> 01 1SBL 32 3001 R <input type="text"/> <input type="text"/> 22	0.850 0.850 0.910

3-pole Contactors - 3 W consumption with spring terminals



IEC Rated current AC-3 380V 400V AC-1 415V $\theta \leq 40^\circ\text{C}$ A A	Aux contacts fitted		Type	Order code	Weight kg
	1 st stk	2 nd stk			
					state coil voltage <input type="text"/> (see table below)
9	23		- - - -	AL 9-30-00ST <input type="text"/>	1SBL 14 3004 R <input type="text"/> <input type="text"/> 00
12	25		- - - -	AL 12-30-00ST <input type="text"/>	1SBL 16 3004 R <input type="text"/> <input type="text"/> 00
17	27		- - - -	AL 16-30-00ST <input type="text"/>	1SBL 18 3004 R <input type="text"/> <input type="text"/> 00

Coil voltages and codes

Voltage - U _c V d.c.	Code
<input type="text"/>	<input type="text"/> <input type="text"/>
12	8 0
24	8 1
42	8 2
48	8 3
50	2 1
60	8 4
75	8 5
110	8 6
125	8 7
220	8 8
240	8 9
250	3 8

AL..Z.. and AL..Z..ST 3-pole Contactors

d.c. Operated



AL 16Z-30-10

1SBC59074F0301



AL 16Z-30-00ST

1SBC59043F0304

Ordering Details

3-pole Contactors - 2.4 W consumption with screw terminals



IEC Rated current AC-3 380V 400V AC-1 415V $\theta \leq 40^\circ\text{C}$ A A	UL Rated power motor General use 480V 600V A	Aux contacts fitted 1 st stk 2 nd stk	Type	Order code	Weight kg		
			state coil voltage <input type="text"/> <input type="text"/> <input type="text"/> (see table below)	state coil voltage code <input type="checkbox"/> <input type="checkbox"/> (see table below)	Pack ^{ing} 1 piece		
9	25	5	21	1 - - - 1 - -	AL 9Z-30-10 <input type="text"/> <input type="text"/> <input type="text"/> AL 9Z-30-01 <input type="text"/> <input type="text"/> <input type="text"/>	1SBL 14 4001 R <input type="checkbox"/> <input type="checkbox"/> 10 1SBL 14 4001 R <input type="checkbox"/> <input type="checkbox"/> 01	0.520 0.520
12	27	7.5	25	1 - - - 1 - -	AL 12Z-30-10 <input type="text"/> <input type="text"/> <input type="text"/> AL 12Z-30-01 <input type="text"/> <input type="text"/> <input type="text"/>	1SBL 16 4001 R <input type="checkbox"/> <input type="checkbox"/> 10 1SBL 16 4001 R <input type="checkbox"/> <input type="checkbox"/> 01	0.520 0.520
17	30	10	30	1 - - - 1 - -	AL 16Z-30-10 <input type="text"/> <input type="text"/> <input type="text"/> AL 16Z-30-01 <input type="text"/> <input type="text"/> <input type="text"/>	1SBL 18 4001 R <input type="checkbox"/> <input type="checkbox"/> 10 1SBL 18 4001 R <input type="checkbox"/> <input type="checkbox"/> 01	0.520 0.520

3-pole Contactors - 2.4 W consumption with spring terminals



IEC Rated current AC-3 380V 400V AC-1 415V $\theta \leq 40^\circ\text{C}$ A A	Aux contacts fitted 1 st stk 2 nd stk	Type	Order code	Weight kg	
		state coil voltage <input type="text"/> <input type="text"/> <input type="text"/> (see table below)	state coil voltage code <input type="checkbox"/> <input type="checkbox"/> (see table below)	Pack ^{ing} 1 piece	
9	23	- - - -	AL 9Z-30-00ST <input type="text"/> <input type="text"/> <input type="text"/> <input type="text"/>	1SBL 14 4004 R <input type="checkbox"/> <input type="checkbox"/> 00	0.580
12	25	- - - -	AL 12Z-30-00ST <input type="text"/> <input type="text"/> <input type="text"/> <input type="text"/>	1SBL 16 4004 R <input type="checkbox"/> <input type="checkbox"/> 00	0.580
17	27	- - - -	AL 16Z-30-00ST <input type="text"/> <input type="text"/> <input type="text"/> <input type="text"/>	1SBL 18 4004 R <input type="checkbox"/> <input type="checkbox"/> 00	0.580

Coil voltages and codes

Voltage - U _c V d.c.	Code
<input type="text"/> <input type="text"/> <input type="text"/>	<input type="checkbox"/> <input type="checkbox"/>
24	1 5
48	2 0

TAL.. and TAL..ST 3-pole Contactors

d.c. Operated



TAL 16-30-10

1SBC390184F0301



TAL 40-30-10

1SBC390224F0301



TAL 16-30-00ST

1SBC390973F0304

Ordering Details

Large coil voltage range with screw terminals



IEC Rated current AC-3 380V 400V AC-1 415V $\theta \leq 40^\circ\text{C}$ A A	UL Rated power motor 480V hp	Rated current General use 600V A	Aux contacts fitted 1 st stk 2 nd stk 	Type	Order code	Weight kg	Pack ^{ing} 1 piece
				state coil voltage <input type="checkbox"/> <input type="checkbox"/> (see table below)	state coil voltage code <input type="checkbox"/> <input type="checkbox"/> (see table below)		
9	25	5	21	1 - - - - 1 - -	TAL 9-30-10 <input type="checkbox"/> <input type="checkbox"/> 1SBL 14 3061 R <input type="checkbox"/> <input type="checkbox"/> 10	0.520	
					TAL 9-30-01 <input type="checkbox"/> <input type="checkbox"/> 1SBL 14 3061 R <input type="checkbox"/> <input type="checkbox"/> 01	0.520	
12	27	7.5	25	1 - - - - 1 - -	TAL 12-30-10 <input type="checkbox"/> <input type="checkbox"/> 1SBL 16 3061 R <input type="checkbox"/> <input type="checkbox"/> 10	0.520	
					TAL 12-30-01 <input type="checkbox"/> <input type="checkbox"/> 1SBL 16 3061 R <input type="checkbox"/> <input type="checkbox"/> 01	0.520	
17	30	10	30	1 - - - - 1 - -	TAL 16-30-10 <input type="checkbox"/> <input type="checkbox"/> 1SBL 18 3061 R <input type="checkbox"/> <input type="checkbox"/> 10	0.520	
					TAL 16-30-01 <input type="checkbox"/> <input type="checkbox"/> 1SBL 18 3061 R <input type="checkbox"/> <input type="checkbox"/> 01	0.520	
26	45	20	40	1 - - - - 1 - -	TAL 26-30-10 <input type="checkbox"/> <input type="checkbox"/> 1SBL 24 3061 R <input type="checkbox"/> <input type="checkbox"/> 10	0.750	
					TAL 26-30-01 <input type="checkbox"/> <input type="checkbox"/> 1SBL 24 3061 R <input type="checkbox"/> <input type="checkbox"/> 01	0.750	
32	55	25	50	1 - - - - 1 - -	TAL 30-30-10 <input type="checkbox"/> <input type="checkbox"/> 1SBL 28 3061 R <input type="checkbox"/> <input type="checkbox"/> 10	0.750	
					TAL 30-30-01 <input type="checkbox"/> <input type="checkbox"/> 1SBL 28 3061 R <input type="checkbox"/> <input type="checkbox"/> 01	0.750	
37	60	30	60	1 - - - - 1 - -	TAL 40-30-10 <input type="checkbox"/> <input type="checkbox"/> 1SBL 32 3061 R <input type="checkbox"/> <input type="checkbox"/> 10	0.850	
					TAL 40-30-01 <input type="checkbox"/> <input type="checkbox"/> 1SBL 32 3061 R <input type="checkbox"/> <input type="checkbox"/> 01	0.850	

Large coil voltage range with spring terminals



IEC Rated current AC-3 380V 400V AC-1 415V $\theta \leq 40^\circ\text{C}$ A A	Aux contacts fitted 1 st stk 2 nd stk 	Type	Order code	Weight kg	Pack ^{ing} 1 piece
		state coil voltage <input type="checkbox"/> <input type="checkbox"/> (see table below)	state coil voltage code <input type="checkbox"/> <input type="checkbox"/> (see table below)		
9	23	- - - -	TAL 9-30-00ST <input type="checkbox"/> <input type="checkbox"/> 1SBL 14 3059 R <input type="checkbox"/> <input type="checkbox"/> 00	0.580	
12	25	- - - -	TAL 12-30-00ST <input type="checkbox"/> <input type="checkbox"/> 1SBL 16 3059 R <input type="checkbox"/> <input type="checkbox"/> 00	0.580	
17	27	- - - -	TAL 16-30-00ST <input type="checkbox"/> <input type="checkbox"/> 1SBL 18 3059 R <input type="checkbox"/> <input type="checkbox"/> 00	0.580	

Note: For technical data and accessory compatibility on the TAL..ST range, please consult us.

Coil voltages and codes

Voltage - U_c V d.c.	Code
<input type="checkbox"/> <input type="checkbox"/>	<input type="checkbox"/> <input type="checkbox"/>
17 ... 32	5 1
25 ... 45	5 2
36 ... 65	5 4
42 ... 78	5 8
50 ... 90	5 5
77 ... 143	6 2
90 ... 150	6 6
152 ... 264	6 8

AL.. and TAL.. 4-pole Contactors



d.c. Operated
Screw Terminals



AL 9-40-00



AL 9-22-00

Ordering Details

IEC Rated current	UL Rated current General use	Aux. contacts fitted	Type	Order code	Weight kg
AC-1 $\theta \leq 40^\circ\text{C}$ A	600V A		state coil voltage <input type="text"/> (see table below)	state coil voltage code <input type="text"/> <input type="text"/> (see table below)	Pack ^{ing} 1 piece

4 N.O. Main Poles - 3 W and 3.5 W consumption

25	21	- -	AL 9-40-00 <input type="text"/>	1SBL 14 3201 R <input type="text"/> <input type="text"/>	0.520
30	30	- -	AL 16-40-00 <input type="text"/>	1SBL 18 3201 R <input type="text"/> <input type="text"/>	0.520
45	40	- -	AL 26-40-00 <input type="text"/>	1SBL 24 3201 R <input type="text"/> <input type="text"/>	0.750

2 N.O. + 2 N.C. Main Poles - 3 W and 3.5 W consumption

25	21	- -	AL 9-22-00 <input type="text"/>	1SBL 14 3501 R <input type="text"/> <input type="text"/>	0.520
30	30	- -	AL 16-22-00 <input type="text"/>	1SBL 18 3501 R <input type="text"/> <input type="text"/>	0.520
45	40	- -	AL 26-22-00 <input type="text"/>	1SBL 24 3501 R <input type="text"/> <input type="text"/>	0.750

4 N.O. Main Poles - Large coil voltage range

25	21	- -	TAL 9-40-00 <input type="text"/>	1SBL 14 3261 R <input type="text"/> <input type="text"/>	0.520
30	30	- -	TAL 16-40-00 <input type="text"/>	1SBL 18 3261 R <input type="text"/> <input type="text"/>	0.520
45	40	- -	TAL 26-40-00 <input type="text"/>	1SBL 24 3261 R <input type="text"/> <input type="text"/>	0.750

2 N.O. + 2 N.C. Main Poles - Large coil voltage range

25	21	- -	TAL 9-22-00 <input type="text"/>	1SBL 14 3561 R <input type="text"/> <input type="text"/>	0.520
30	30	- -	TAL 16-22-00 <input type="text"/>	1SBL 18 3561 R <input type="text"/> <input type="text"/>	0.520
45	40	- -	TAL 26-22-00 <input type="text"/>	1SBL 24 3561 R <input type="text"/> <input type="text"/>	0.750

Coil voltages and codes AL..

Voltage - U_c V d.c. <input type="text"/>	Code <input type="text"/> <input type="text"/>
12	8 0
24	8 1
48	8 3
50	2 1
60	8 4
75	8 5
110	8 6
125	8 7
220	8 8
240	8 9
250	3 8

Coil voltages and codes TAL..

Voltage - U_c V d.c. <input type="text"/>	Code <input type="text"/> <input type="text"/>
17 ... 32	5 1
25 ... 45	5 2
36 ... 65	5 4
42 ... 78	5 8
50 ... 90	5 5
77 ... 143	6 2
90 ... 150	6 6
152 ... 264	6 8

>> Technical Data pages 17 ... 27

>> Dimensions pages 47 ... 23

Main Accessories for AL.. and AL..ST Contactors

Contactor and main accessories

Other accessories:  page 12

Screw terminals

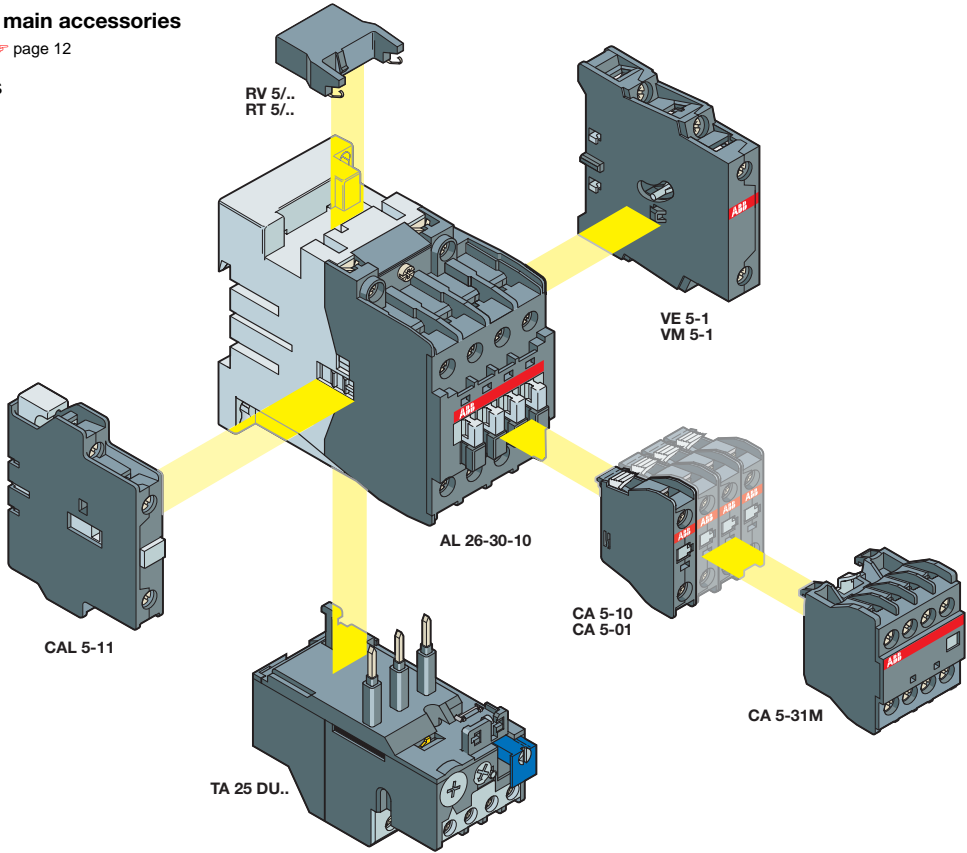

1SBC50004F0000

Contactor and main accessories

Other accessories:  page 14

Spring terminals

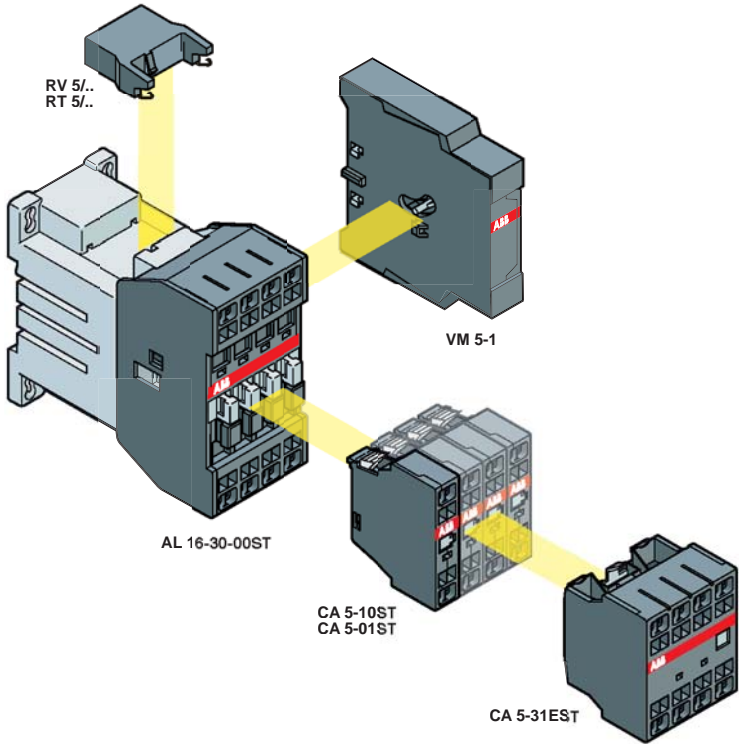





1SBC50007F0000

Accessory Compatibility for AL.. Contactors

Screw Terminals

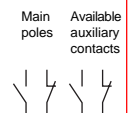
Compatibility between the Main Accessories

Many configurations are possible depending upon whether they are front-mounted or side-mounted.

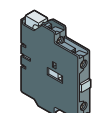
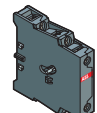
Contactor configuration	Front-mounted accessories	Side-mounted accessories
 <p>Main poles Available auxiliary contacts</p> <p>Contactor types</p>	 <p>Auxiliary contact 1-pole CA 5-..</p>  <p>Auxiliary contact 4-pole CA 5-..</p>  <p>Auxiliary contact 1-pole CE 5-..</p>	 <p>Auxiliary contact 2-pole CAL 5-11</p>  <p>Interlock unit VM 5-.. or VE 5-..</p>

Position 1±30° not permitted

AL 9 to AL 16 Contactors

AL 9 ... AL 16	3 0 1 0	1 to 4 x CA 5-..(1) or 1 x CA 5-.. (4-pole) (1) or 1 to 2 x CE 5-.. (2) or 1 x CAL 5-11	+ 1 x VM 5-1(3) or VE 5-1(3)(4)
AL 9 ... AL 16	3 0 0 1		
AL 9 ... AL 16	3 0 2 2	–	1 x VM 5-1 or VE 5-1
AL 9 ... AL 16	4 0 0 0	1 to 4 x CA 5-..(1) or 1 x CA 5-.. (4-pole) (1) or 1 to 2 x CE 5-.. (2) or 1 x CAL 5-11	+ 1 x VM 5-1(3) or VE 5-1(3)(4)
AL 9 ... AL 16 (8)	2 2 0 0	1 to 4 x CA 5-..(5) or 1 x CA 5-.. (4-pole) (5)	–

- (1) 2 N.C. auxiliary contacts maximum in all mounting positions except 5. In position 5 no N.C. are allowed.
- (2) CE 5-.. not allowed in position 5.
- (3) When VM5-1 or VE5-1 is used with CAL 5-11 the control voltage is limited to 0.9 U_c ... 1.1 U_c.
- (4) With VE5-1 a maximum of 3 N.O. auxiliary contacts are permitted.
- (5) 2 N.C. auxiliary contacts maximum.
- (8) Mounting position 5 is not allowed.

AL 26 to AL 40 Contactors

AL 26	3 0 1 0	1 to 4 x CA 5-..(6) or 1 x CA 5-.. (4-pole) (6) or 1 to 2 x CE 5-..	or 1 x CAL 5-11	+ 1 x VM 5-1 or VE 5-1	
AL 26	3 0 0 1				
AL 26	3 0 2 2	–	–	+ 1 x VM 5-1 or VE 5-1	
AL 30, AL 40	3 0 1 0	1 to 5 x CA 5-..(6) or 1 x CA 5-.. (4-pole) (6) + 1 x CA 5-.. (1-pole)	or 1 to 2 x CE 5-..	or 1 x CAL 5-11	+ 1 x VM 5-1 or VE 5-1(4)
AL 30, AL 40	3 0 0 1				
AL 30, AL 40	3 0 2 2	–	–	1 x VM 5-1 or VE 5-1	
AL 26	4 0 0 0	1 to 4 x CA 5-..(6) or 1 x CA 5-.. (4-pole) (6) or 1 to 2 x CE 5-..	or 1 x CAL 5-11	+ 1 x VM 5-1 or VE 5-1	
AL 26 (8)	2 2 0 0	1 to 4 x CA 5-..(7) or 1 x CA 5-.. (4-pole) (7)	–	or 1 x CAL 5-11	

- (4) With VE5-1 a maximum of 3 N.O. auxiliary contacts are permitted.
- (6) 2 N.C. auxiliary contacts maximum in mounting position 5.
- (7) N.C. auxiliary contacts are not allowed.
- (8) Mounting position 5 is not allowed.

Conditions for Use: Please see page 23

Mounting Positions

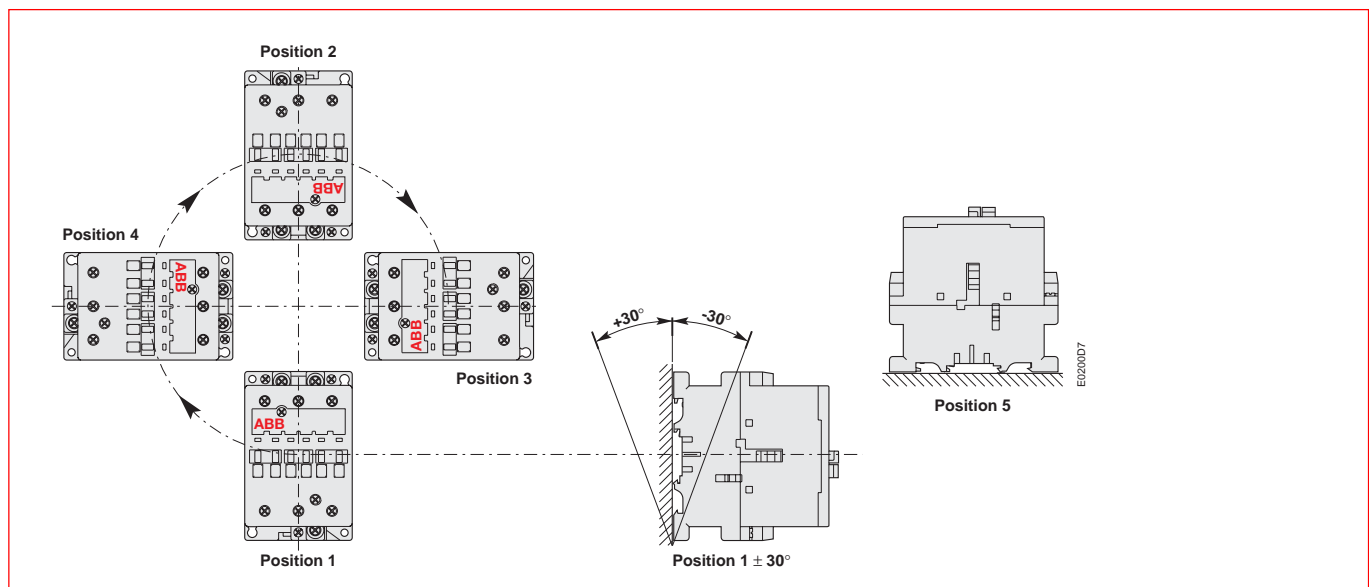





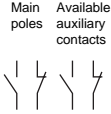

Accessory Compatibility for AL..Z.. and TAL.. Contactors

Screw Terminals

Compatibility between the Main Accessories

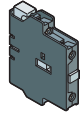
Many configurations are possible depending upon whether they are front-mounted or side-mounted.

Contactor configuration	Front-mounted accessories	Side-mounted accessories
 <p>Main poles Available auxiliary contacts</p> <p>Contactor types</p>	 <p>Auxiliary contact 1-pole CA 5-..</p>  <p>Auxiliary contact 4-pole CA 5-..</p>  <p>Auxiliary contact 1-pole CE 5-..</p>	 <p>Interlock unit 2-pole CAL 5-11</p>  <p>VM 5-.. or VE 5-..</p>
		Position 1±30° not permitted

AL..Z.. and TAL 9 to TAL 16 Contactors

AL 9Z ... AL 16Z (9)	3 0	1 0	1 to 2 x CA 5-..(1)	–	or 1 to 2 x CE 5-.. (2)	–	–
AL 9Z ... AL 16Z (9)	3 0	0 1	1 to 2 x CA 5-..(1)	–	or 1 to 2 x CE 5-.. (2)	–	or VM 5-1
TAL 9 ... TAL 16	3 0	1 0	1 to 4 x CA 5-..(1)	or 1 x CA 5-.. (4-pole) (1)	or 1 to 2 x CE 5-.. (2)	or 1 x CAL 5-11	+ 1 x VM 5-1(3) or VE 5-1(3)(5)
TAL 9 ... TAL 16	3 0	0 1	1 to 4 x CA 5-..(1)	or 1 x CA 5-.. (4-pole) (1)	or 1 to 2 x CE 5-.. (2)	or 1 x CAL 5-11	+ 1 x VM 5-1(3) or VE 5-1(3)(5)
TAL 9 ... TAL 16	4 0	0 0	1 to 4 x CA 5-..(1)	or 1 x CA 5-.. (4-pole) (1)	or 1 to 2 x CE 5-.. (2)	or 1 x CAL 5-11	+ 1 x VM 5-1(3) or VE 5-1(3)(5)
TAL 9 ... TAL 16 (8)	2 2	0 0	1 to 4 x CA 5-..(4)	or 1 x CA 5-.. (4-pole) (4)	–	or 1 x CAL 5-11	–

- (1) 2 N.C. auxiliary contacts maximum in all mounting positions except 5. In position 5 no N.C. are allowed.
 (2) CE 5-.. not allowed in position 5.
 (3) When VM 5-1 or VE 5-1 is used the CAL 5-11 is not permitted in any positions.
 (4) 2 N.C. auxiliary contacts maximum.
 (5) With VE 5-1 a maximum of 3 N.O. auxiliary contacts are permitted.
 (8) Mounting position 5 is not allowed.
 (9) Not allowed in position 1±30°.

TAL 26 to TAL 40 Contactors

TAL 26	3 0	1 0	1 to 4 x CA 5-..(6)	or 1 x CA 5-.. (4-pole) (6)	or 1 to 2 x CE 5-..	or 1 x CAL 5-11	+ 1 x VM 5-1 or VE 5-1
TAL 26	3 0	0 1	1 to 4 x CA 5-..(6)	or 1 x CA 5-.. (4-pole) (6)	or 1 to 2 x CE 5-..	or 1 x CAL 5-11	+ 1 x VM 5-1 or VE 5-1
TAL 30, AL 40	3 0	1 0	1 to 5 x CA 5-..(6)	or 1 x CA 5-.. (4-pole) (6)	or 1 to 2 x CE 5-..	or 1 x CAL 5-11	+ 1 x VM 5-1 or VE 5-1(5)
TAL 30, AL 40	3 0	0 1	1 to 5 x CA 5-..(6)	or 1 x CA 5-.. (4-pole) (6)	or 1 to 2 x CE 5-..	or 1 x CAL 5-11	+ 1 x VM 5-1 or VE 5-1(5)
TAL 26	4 0	0 0	1 to 4 x CA 5-..(6)	or 1 x CA 5-.. (4-pole) (6)	or 1 to 2 x CE 5-..	or 1 x CAL 5-11	+ 1 x VM 5-1 or VE 5-1
TAL 26 (8)	2 2	0 0	1 to 4 x CA 5-..(7)	or 1 x CA 5-.. (4-pole) (7)	–	or 1 x CAL 5-11	–

- (5) With VE 5-1 a maximum of 3 N.O. auxiliary contacts are permitted.
 (6) 2 N.C. auxiliary contacts maximum in position 5.
 (7) N.C. auxiliary contacts are not allowed.
 (8) Mounting position 5 is not allowed.

Conditions for Use: Please see page 23

Mounting Positions

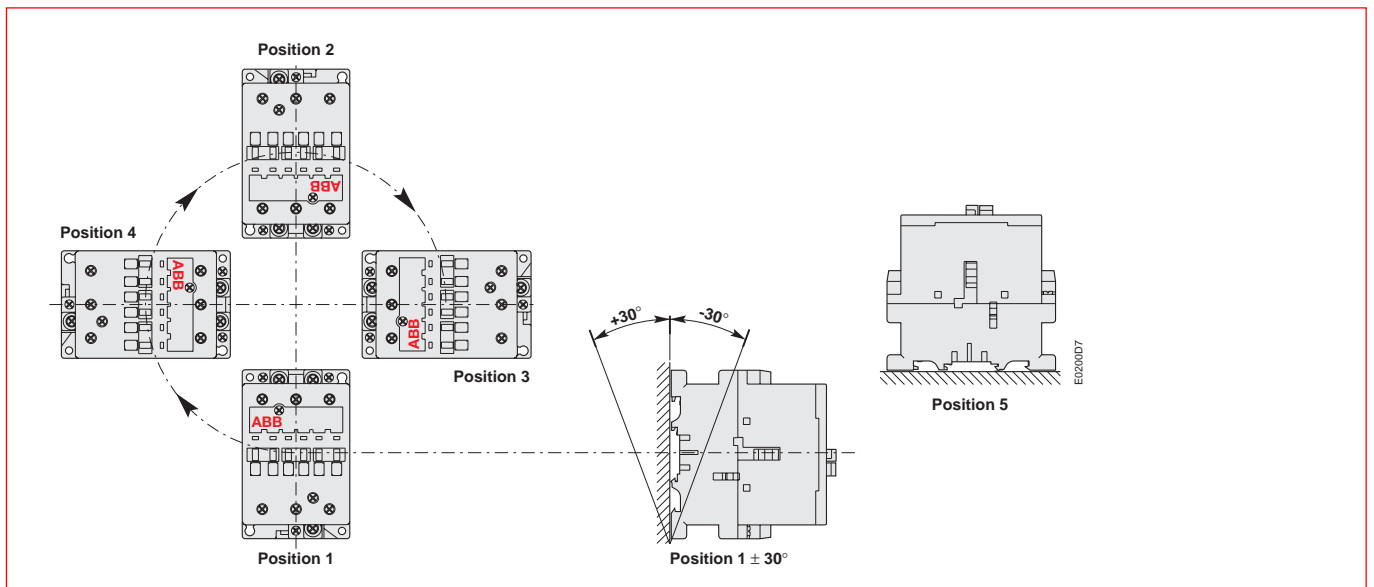

AL., AL..Z., TAL.. Contactors

Accessories

Screw Terminals

Ordering Details

Auxiliary Contact Blocks

Mounting on contactors	Positioning	Contacts	Type	Order Code	Pack ^{ing} piece	Weight kg
						1 piece
AL, AL..Z, TAL (3-pole)	Front face	1 – – 1	CA 5-10 CA 5-01	1SBN 01 0010 R1010 1SBN 01 0010 R1001	10 10	0.014 0.014
AL, TAL (3-pole)	Front face	3 1 2 2	CA 5-31 M CA 5-22 M	1SBN 01 0040 R1131 1SBN 01 0040 R1122	2 2	0.060 0.060
AL, TAL (4-pole)	Front face	4 0 2 2	CA 5-40 E CA 5-22 E	1SBN 01 0040 R1040 1SBN 01 0040 R1022	2 2	0.060 0.060
AL, TAL	Side	1 1	CAL 5-11	1SBN 01 0020 R1011	2	0.050

See the accessory compatibility table pages 10 & 11.

Electronic Timers for star-delta starters (dwelling time 50 ms)

Mounting	Timing range	Supply voltage V	Type	Order Code	Pack ^{ing} piece	Weight kg
Independent	Direct	24 a.c. / d.c.	TE5S-24	1SBN 02 0010 R1001	1	0.080

Interlocks

Mounting on contactors	Feature	Contacts	Type	Order Code	Pack ^{ing} piece	Weight kg
						
AL, TAL	Mech. / electrical	– 2	VE 5-1	1SBN 03 0110 R1000	1	0.076
AL, AL..Z, TAL	Mechanical	– –	VM 5-1	1SBN 03 0100 R1000	1	0.066

Surge Suppressors

Mounting on contactors	Feature	Voltage range	Type	Order Code	Pack ^{ing} piece	Weight kg
						1 piece
AL, AL..Z, TAL	Varistor	24 ... 50 V a.c. / d.c.	RV 5/50	1SBN 05 0010 R1000	2	0.015
		50 ... 133 V a.c. / d.c.	RV 5/133	1SBN 05 0010 R1001	2	0.015
		110 ... 250 V a.c. / d.c.	RV 5/250	1SBN 05 0010 R1002	2	0.015
		250 ... 440 V a.c. / d.c.	RV 5/440	1SBN 05 0010 R1003	2	0.015
AL, AL..Z, TAL	Transil Diode	12 ... 32 V d.c.	RT 5/32	1SBN 05 0020 R1000	2	0.015
		25 ... 65 V d.c.	RT 5/65	1SBN 05 0020 R1001	2	0.015
		50 ... 90 V d.c.	RT 5/90	1SBN 05 0020 R1002	2	0.015
		77 ... 150 V d.c.	RT 5/150	1SBN 05 0020 R1003	2	0.015
		150 ... 264 V d.c.	RT 5/264	1SBN 05 0020 R1004	2	0.015

Function Marker

Mounting on contactors	Feature	Type	Order Code	Pack ^{ing} box	Weight kg
AL, AL..Z, TAL	50 Pieces in a box	BA 5-50	1SBN 11 0000 R1000	1	0.017



CAL 5-11



CA 5-10



TE5S-24



VE 5-1

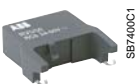

RV 5/50



RT 5/32





BA 5-50

Accessory Compatibility for AL..ST Contactors

Spring Terminals

Compatibility between the Main Accessories

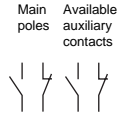
Many configurations are possible depending upon whether they are front-mounted or side-mounted.

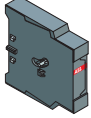
Contactor configuration	Front-mounted accessories	Side-mounted accessory
<p>Contactor types</p> 	<p>Auxiliary contact 1-pole CA 5-..ST</p>  <p>Auxiliary contact 4-pole CA 5-..ST</p> 	<p>Mechanical interlock unit VM 5-1</p> 

AL 9..ST to AL 16..ST Contactors

AL 9..ST ... AL 16..ST	3 0 0 0	1 to 4 x CA 5-..ST(1) or 1 x CA 5-..ST (4-pole) (1)	+	1 x VM 5-1
------------------------	---------	-----------------------------------------------------	---	------------

AL 9Z..ST to AL 16Z..ST Contactors

AL 9Z..ST ... AL 16Z..ST(2)	3 0 0 0	1 to 2 x CA 5-..ST(1)	-	or 1 x VM 5-1
-----------------------------	---------	-----------------------	---	---------------

(1) 2 N.C. auxiliary contacts maximum in all mounting positions except 5. In position 5 no N.C. are allowed.
 (2) Not allowed in position 1±30°.

Conditions for Use: Please see page 23

Mounting Positions

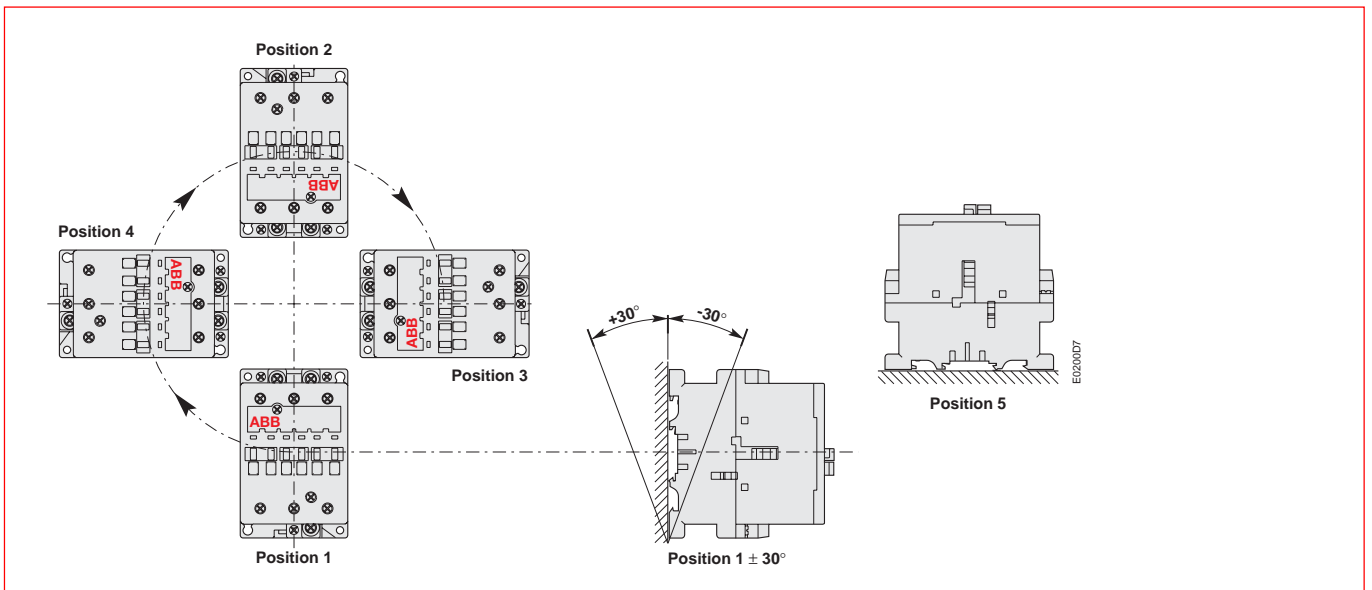

AL..ST and AL..Z..ST Contactors

Accessories

Spring Terminals



Ordering Details

Auxiliary Contact Blocks

Mounting on contactors	Positioning	Contacts	Type	Order Code	Pack ^{ing} piece	Weight kg
AL..ST, AL..Z..ST	Front face	1 –	CA 5-10ST	1SBN 01 1419 R1010	10	0.016
		– 1	CA 5-01ST	1SBN 01 1419 R1001	10	0.016
		4 0	CA 5-40 EST	1SBN 01 1445 R1040	2	0.060
		3 1	CA 5-31 EST	1SBN 01 1445 R1031	2	0.060
		2 2	CA 5-22 EST	1SBN 01 1445 R1022	2	0.060

See the accessory compatibility table page 13.

Interlocks

Mounting on contactors	Feature	Contacts	Type	Order Code	Pack ^{ing} piece	Weight kg
AL..ST, AL..Z..ST	Mechanical	– –	VM 5-1	1SBN 03 0100 R1000	1	0.066

Surge Suppressors

Mounting on contactors	Feature	Voltage range	Type	Order Code	Pack ^{ing} piece	Weight kg
AL..ST, AL..Z..ST	Varistor	24 ... 50 V a.c. / d.c.	RV 5/50	1SBN 05 0010 R1000	2	0.015
		50 ... 133 V a.c. / d.c.	RV 5/133	1SBN 05 0010 R1001	2	0.015
		110 ... 250 V a.c. / d.c.	RV 5/250	1SBN 05 0010 R1002	2	0.015
		250 ... 440 V a.c. / d.c.	RV 5/440	1SBN 05 0010 R1003	2	0.015
AL..ST, AL..Z..ST	Transil Diode	12 ... 32 V d.c.	RT 5/32	1SBN 05 0020 R1000	2	0.015
		25 ... 65 V d.c.	RT 5/65	1SBN 05 0020 R1001	2	0.015
		50 ... 90 V d.c.	RT 5/90	1SBN 05 0020 R1002	2	0.015
		77 ... 150 V d.c.	RT 5/150	1SBN 05 0020 R1003	2	0.015
		150 ... 264 V d.c.	RT 5/264	1SBN 05 0020 R1004	2	0.015

Function Marker

Mounting on contactors	Feature	Type	Order Code	Pack ^{ing} box	Weight kg
AL..ST, AL..Z..ST	50 Pieces in a box	BA 5-50	1SBN 11 0000 R1000	1	0.017

Note: Some accessories with screw terminals can be used with the ...ST contactors, these include:

- TE5S Electronic timer
- TA25 DU Thermal overload relay with the independent mounting kit DB25.



CA 5-10ST



CA 5-40 EST



VM 5-1



RV 5/50



RT 5/32



BA 5-50

AL..., AL...Z..., TAL... 3-pole Contactors

Thermal O/L Relays



AL ...



TA 25 DU



TA 42 DU

Fitting Details

The addition of a thermal O/L on the contactor does not prevent fitting of many other accessories as shown and described on pages 9 ... 12.

Contactor type	AL 9 ... AL 26 AL 9Z ... AL 16Z TAL 9 ... TAL 26	AL 30 ... AL 40 TAL 30 ... TAL 40
Thermal O/L relay	TA 25 DU ..	TA 25 DU .. (1) TA 42 DU .. (1)

(1) According to the setting range related to the motor F.L.C.

Ordering Details

Thermal O/L Relays, Class 10A

For contactors:	Setting range	Type	Order code	Weight kg Pack ^{ing} 1 piece
	A			
	0.10 ... 0.16	TA 25 DU 0.16	1SAZ 21 1201 R1005	0.150
	0.16 ... 0.25	TA 25 DU 0.25	1SAZ 21 1201 R1009	0.150
	0.25 ... 0.40	TA 25 DU 0.4	1SAZ 21 1201 R1013	0.150
	0.40 ... 0.63	TA 25 DU 0.63	1SAZ 21 1201 R1017	0.150
	0.63 ... 1.00	TA 25 DU 1.0	1SAZ 21 1201 R1021	0.150
	1.0 ... 1.4	TA 25 DU 1.4	1SAZ 21 1201 R1023	0.150
	1.3 ... 1.8	TA 25 DU 1.8	1SAZ 21 1201 R1025	0.150
	1.7 ... 2.4	TA 25 DU 2.4	1SAZ 21 1201 R1028	0.150
AL 9 ... AL 30	2.2 ... 3.1	TA 25 DU 3.1	1SAZ 21 1201 R1031	0.150
AL 9Z ... AL 16Z	2.8 ... 4.0	TA 25 DU 4.0	1SAZ 21 1201 R1033	0.150
TAL 9 ... TAL 30	3.5 ... 5.0	TA 25 DU 5.0	1SAZ 21 1201 R1035	0.150
	4.5 ... 6.5	TA 25 DU 6.5	1SAZ 21 1201 R1038	0.150
	6.0 ... 8.5	TA 25 DU 8.5	1SAZ 21 1201 R1040	0.150
	7.5 ... 11	TA 25 DU 11	1SAZ 21 1201 R1043	0.150
	10 ... 14	TA 25 DU 14	1SAZ 21 1201 R1045	0.150
	13 ... 19	TA 25 DU 19	1SAZ 21 1201 R1047	0.150
	18 ... 25	TA 25 DU 25	1SAZ 21 1201 R1051	0.150
	24 ... 32	TA 25 DU 32	1SAZ 21 1201 R1053	0.170
AL 30 ... AL 40	18 ... 25	TA 42 DU 25	1SAZ 31 1201 R1001	0.330
TAL 30 ... TAL 40	22 ... 32	TA 42 DU 32	1SAZ 31 1201 R1002	0.330
	29 ... 42	TA 42 DU 42	1SAZ 31 1201 R1003	0.330

Separate Mounting Kit

For O/L relays:	Type	Order code	Weight kg Pack ^{ing} 1 piece
TA 25 DU ≤ 25	DB 25/25 A	1SAZ 20 1108 R0001	0.050
TA 25 DU 32	DB 25/32 A	1SAZ 20 1108 R0002	0.075
TA 42 DU	DB 80	1SAZ 30 1110 R0001	0.170

D.O.L. Starting with Manual Motor Starter

Screw Terminals



MS 116



BSA



AL 16-30-10

Fitting Details

Direct on line starter with protection against short circuits. To be supplied in kit form and to be assembled by the customer. Coordination Type 1 in accordance with IEC 60947-4-1

kW	I (A)	MMS	Contactora	Connexion Kit	Fixing
4	9	MS 116	AL 9	BSA 325	Rail 35 mm
5.5	12	MS 116	AL 12	BSA 325	Rail 35 mm
7.5	16	MS 116	AL 16	BSA 325	Rail 35 mm
11	26	MS 325	AL 26	BSA 325	Rail 35 mm
15	30	MS 450	AL 30	-	Screws
18.5	40	MS 450	AL 40	-	Screws

400V, 50kA, Normal Start up, Type 1

Manual Motor Starters

Motor		Manuel Motor-Starter				Contactora
Rated Output	Rated Current	Type	Order Cde	Magnetic Tripping current (A)	O/L Current Setting range (A)	Type
P _e (kW)	I _e (A)					
0.37	1.2	MS 116-1.6	1SAM250000R1006	19.2	1 - 1.6	AL 9
0.55	1.5	MS 116-1.6	1SAM250000R1006	19.2	1 - 1.6	AL 9
0.75	2	MS 116-2.5	1SAM250000R1007	30	1.6 - 2.5	AL 9
1.1	2.6	MS 116-4	1SAM250000R1008	48	2.5 - 4	AL 9
1.5	3.5	MS 116-4	1SAM250000R1008	48	2.5 - 4	AL 9
2.2	5	MS 116-6.3	1SAM250000R1009	75.6	4 - 6.3	AL 9
3	6.6	MS 325-9	1SAM150000R1010	135	6.3 - 9	AL 9
4	8.5	MS 325-9	1SAM150000R1010	135	6.3 - 9	AL 9
5.5	11.5	MS 325-12.5	1SAM150000R1011	187.5	9 - 12.5	AL 12
7.5	15.5	MS 325-16	1SAM150000R1012	240	12.5 - 16	AL 16
7.5	15.5	MS 450-20	1SAM450000R1002	240	14 - 20	AL 16
9	18.3	MS 325-20	1SAM150000R1013	300	16 - 20	AL 26
11	22	MS 325-25	1SAM150000R1014	375	20 - 25	AL 26
11	22	MS 450-25	1SAM450000R1003	300	18 - 25	AL 26
15	30	MS 450-32	1SAM450000R1004	384	22 - 32	AL 30
18.5	37	MS 450-40	1SAM450000R1005	480	28 - 40	AL 40

Connection Kit

For motor starters	Type	Order code	Weight kg Pack ^{ing} 1 piece
MS 116, MS 325	BSA 325	FPTN 472772 R0001	0.009

AL.., AL..ST, AL..Z.., AL..Z..ST, TAL.. Contactors

Technical Data

General Technical Data - Contactor with Screw Terminals

Contactor types: AL.., TAL..	9	12	16	26	30	40
AL..Z..	9	12	16	-	-	-
Rated insulation voltage U_i according to IEC 60947-4-1	V 1000					
according to UL/CSA	V 600					
Rated impulse withstand voltage U_{imp}	kV 8					
Standards	Devices complying with international standards IEC 60947-1 / 60947-4-1 and European standards EN 60947-1 / 60947-4-1					
Certifications - Approvals	UL, CSA					
Air temperature close to contactor	☞ " Conditions for use" page 23, for control voltage limits and authorized mounting positions					
– fitted with thermal O/L relay	°C -25 to +55					
– without thermal O/L relay	°C -40 to +70 (55°C for TAL..)					
– for storage	°C -60 to +80					
Climatic withstand	acc. to IEC 60068-2-30 and 60068-2-11 - UTE C 63-100 specification II					
Operating altitude	m ≤ 3000					
Shock withstand acc. IEC 60068-2-27 and EN 60068-2-27 Mounting position 1 (☞ page 23)	1/2 sinusoidal shock for 11 ms: no change in contact position					
	Shock direction	Closed position	Open position			
	A	20 g	10 g			
	B1	15 g	5 g			
	B2	10 g	15 g			
	C1	20 g	8 g			
	C2	14 g	8 g			

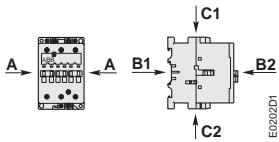

General Technical Data - Contactor with Spring Terminals

Contactor types: AL..ST, AL..Z..ST	9	12	16	-	-	-
Rated insulation voltage U_i according to IEC 60947-4-1	V 690					
Rated impulse withstand voltage U_{imp}	kV 6					
Standards	Devices complying with international standards IEC 60947-1 / 60947-4-1 and European standards EN 60947-1 / 60947-4-1					
Air temperature close to contactor	☞ " Conditions for use" page 23, for control voltage limits and authorized mounting positions					
– without thermal O/L relay	°C -40 to +70					
– for storage	°C -60 to +80					
Climatic withstand	acc. to IEC 60068-2-30 and 60068-2-11 - UTE C 63-100 specification II					
Operating altitude	m ≤ 3000					

AL..., AL..Z..., TAL... Contactors

Technical Data - IEC Ratings

Screw Terminals

Main Pole - Utilization Characteristics



Contactor types: AL..., TAL...	9	12	16	26	30	40
AL..Z...	9	12	16	—	—	—
Rated operational voltage U_e max. V	690					
Rated frequency limits Hz	25 ... 400					
Conventional free-air thermal current I_{th} acc. to IEC 60947-4-1, open contactors $\theta \leq 40^\circ\text{C}$	A 26	28	30	45	65	65
with conductor cross-sectional area mm²	4	4	4	6	16	16
Rated operational current I_e / AC-1 for air temperature close to contactor						
U_e max. 690 V						
$\theta \leq 40^\circ\text{C}$	A 25	27	30	45	55	60
$\theta \leq 55^\circ\text{C}$	A 22	25	27	40	55	60
$\theta \leq 70^\circ\text{C}$	A 18	20	23	32	39	42
with conductor cross-sectional area mm²	2.5	4	4	6	10	16
Utilization category AC-3 for air temperature close to contactor $\leq 55^\circ\text{C}$						
Rated operational current I_e AC-3						
220-230-240 V	A 9	12	17	26	33	40
3-phase motors 380-400 V	A 9	12	17	26	32	37
415 V	A 9	12	17	26	32	37
440 V	A 9	12	16	26	32	37
500 V	A 9	12	14	22	28	33
690 V	A 7	9	10	13	18	21
Rated operational power AC-3						
1500 r.p.m. 50 Hz 220-230-240 V	kW 2.2	3	4	6.5	9	11
1800 r.p.m. 60 Hz 380-400 V	kW 4	5.5	7.5	11	15	18.5
3-phase motors 415 V	kW 4	5.5	9	11	15	18.5
440 V	kW 4	5.5	9	15	18.5	22
500 V	kW 5.5	7.5	9	15	18.5	22
690 V	kW 5.5	7.5	9	11	15	18.5
Rated making capacity AC-3 according to IEC 60947-4-1	10 x I_e AC-3					
Rated breaking capacity AC-3 according to IEC 60947-4-1	8 x I_e AC-3					
Short-circuit protection for contactors without thermal O/L relay - Motor protection excluded $U_e \leq 500$ V a.c. - gG type fuse	A 25	32	32	50	63	
Rated short-time withstand current I_{sw} at 40 °C ambient temp., in free air, from a cold state						
1 s	A 250	280	300	400	600	
10 s	A 100	120	140	210	400	
30 s	A 60	70	80	110	225	
1 min	A 50	55	60	90	150	
15 min	A 26	28	30	45	65	
Maximum breaking capacity $\cos \varphi = 0.45$ ($\cos \varphi = 0.35$ for $I_e > 100$ A)						
at 440 V	A 250			420	470	
at 690 V	A 100			106	175	
Heat dissipation per pole I_e / AC-1	W 0.8	1	1.2	1.8	2.5	3
I_e / AC-3	W 0.1	0.2	0.35	0.6	0.9	1.3
Max. electrical switching frequency						
– for AC-1	cycles/h 600					
– for AC-3	cycles/h 1200					
– for AC-2, AC-4	cycles/h 300					
Mechanical durability						
– millions of operating cycles	10					
– max. mechanical switching frequency	cycles/h 3600					

AL..ST, AL..Z..ST Contactors

Technical Data - IEC Ratings

Spring Terminals

Main Pole - Utilization Characteristics



Contactor types: AL..ST, AL..Z..ST	9	12	16	—	—	—
Rated operational voltage U_e max. V	690					
Rated frequency limits Hz	25 ... 400					
Conventional free-air thermal current I_{th} acc. to IEC 60947-4-1, open contactors $\theta \leq 40^\circ\text{C}$						
A	24	25	27			
with conductor cross-sectional area mm²	4	4	4			
Rated operational current I_e / AC-1 for air temperature close to contactor						
U_e max. 690 V	$\theta \leq 40^\circ\text{C}$	A 23	A 25	A 27		
	$\theta \leq 55^\circ\text{C}$	A 18	A 20	A 22		
	$\theta \leq 70^\circ\text{C}$	A 15	A 16	A 17		
with conductor cross-sectional area mm²	2.5	4	4			
Utilization category AC-3 for air temperature close to contactor $\leq 55^\circ\text{C}$						
Rated operational current I_e AC-3						
	220-230-240 V	A 9	12	17		
	3-phase motors 380-400 V	A 9	12	17		
	415 V	A 9	12	17		
	440 V	A 9	12	16		
	500 V	A 9	12	14		
	690 V	A 7	9	10		
Rated operational power AC-3						
	1500 r.p.m. 50 Hz 220-230-240 V	kW 2.2	3	4		
	1800 r.p.m. 60 Hz 3-phase motors 380-400 V	kW 4	5.5	7.5		
	415 V	kW 4	5.5	9		
	440 V	kW 4	5.5	9		
	500 V	kW 5.5	7.5	9		
	690 V	kW 5.5	7.5	9		
Rated making capacity AC-3 according to IEC 60947-4-1						
	10 x I_e AC-3					
Rated breaking capacity AC-3 according to IEC 60947-4-1						
	8 x I_e AC-3					
Short-circuit protection for contactors without thermal O/L relay - Motor protection excluded						
$U_e \leq 500\text{ V a.c.}$ - gG type fuse	A	25	25	32		
Rated short-time withstand current I_{cw} at 40°C ambient temp., in free air, from a cold state						
	1 s	A 250	280	300		
	10 s	A 100	120	140		
	30 s	A 60	70	80		
	1 min	A 50	55	60		
	15 min	A 24	25	27		
Maximum breaking capacity $\text{COS } \varphi = 0.45$ ($\text{COS } \varphi = 0.35$ for $I_e > 100\text{ A}$)						
	at 440 V	A 250				
	at 690 V	A 100				
Heat dissipation per pole						
	I_e / AC-1	W 1.6	1.8	2.0		
	I_e / AC-3	W 0.24	0.4	0.8		
Max. electrical switching frequency						
- for AC-1	cycles/h	600				
- for AC-3	cycles/h	1200				
- for AC-2, AC-4	cycles/h	300				
Mechanical durability						
- millions of operating cycles		10				
- max. mechanical switching frequency	cycles/h	3600				

AL.., AL..Z.., TAL.. Contactors

Technical Data - UL/CSA Ratings

Screw Terminals

Main Pole - Utilization Characteristics

Contactor types: AL.., TAL..	9	12	16	26	30	40
AL..Z..	9	12	16	—	—	—
Rated operational voltage U_e max. V	600					
General use I_e for air temperature close to contactor U_e max. 600 V $\theta \leq 40$ °C A	21	25	30	40	50	60
Amp motor ratings 3-phase motors						
 { 240 V A 6.8 9.6 15.2 28 28 42 480 V A 7.6 11 14 27 34 40 600 V A 9 11 17 27 32 41						
hp motor ratings 3-phase motors						
 { 240 V hp 2 3 5 10 10 15 480 V hp 5 7.5 10 20 25 30 600 V hp 7.5 10 15 25 30 40						
Max. electrical switching frequency						
– for General use cycles/h	600					
– for Motor use cycles/h	1200					

AL..., AL..ST, AL..Z..., AL..Z..ST, TAL.. Contactors

Technical Data

Screw Terminals and Spring Terminals

Magnet System Characteristics for AL.. and AL..ST Contactors

Contactor types: AL.. (3 W / 3.5 W)	9	12	16	26	30	40
AL..ST (3 W)	9	12	16	—	—	—
Rated control circuit voltage U_c V d.c.	12 ... 250					
Coil operating limits according to IEC 60947-4-1	See conditions for use page 23					
Drop-out voltage in % of U_c	roughly 10 ... 30 %					
Coil consumption - Average values						
– pull-in value W	3.0			3.5		
– holding value W	3.0			3.5		
Operating time						
between coil energization and:						
– N.O. contact closing ms	50 ... 100			55 ... 110		
– N.C. contact opening ms	20 ... 70			25 ... 75		
between coil de-energization and:						
– N.O. contact opening ms	10 ... 17 (1)			12 ... 18 (1)		
– N.C. contact closing ms	16 ... 27 (1)			18 ... 28 (1)		

(1) The use of surge suppressors increases the opening time on a scale of 1.1 to 1.5 for a varistor suppressor and on a scale of 1.5 to 3 for a transil diode suppressor.

Magnet System Characteristics for AL.. Z and AL..Z..ST Contactors

Contactor types: AL..Z (2.4 W)	9	12	16	—	—	—
AL..Z..ST (2.4 W)	9	12	16	—	—	—
Rated control circuit voltage U_c V d.c.	24 and 48					
Coil operating limits according to IEC 60947-4-1	See conditions for use page 23					
Drop-out voltage in % of U_c	roughly 10 ... 30 %					
Coil consumption - Average values						
– pull-in value W	2.4					
– holding value W	2.4					
Operating time						
between coil energization and:						
– N.O. contact closing ms	50 ... 100					
– N.C. contact opening ms	20 ... 70					
between coil de-energization and:						
– N.O. contact opening ms	10 ... 17 (1)					
– N.C. contact closing ms	16 ... 27 (1)					

(1) The use of surge suppressors increases the opening time on a scale of 1.1 to 1.5 for a varistor suppressor and on a scale of 1.5 to 3 for a transil diode suppressor.

Magnet System Characteristics for TAL.. Contactors

Contactor types: TAL..	9	12	16	26	30	40
Rated control circuit voltage U_c V d.c.	9 ... 264					
Coil operating limits according to IEC 60947-4-1	See conditions for use page 23					
Drop-out voltage in % of U_c	roughly 20 ... 35 %					
Coil consumption at pull-in and holding						
– U_c max. W	8.5			9		
– U_c min. W	2.5			2.7		
– U_c W	5			5.4		
Operating time						
between coil energization and:						
– N.O. contact closing ms	50 ... 100			55 ... 110		
– N.C. contact opening ms	20 ... 70			25 ... 75		
between coil de-energization and:						
– N.O. contact opening ms	10 ... 17 (1)			12 ... 18 (1)		
– N.C. contact closing ms	16 ... 27 (1)			18 ... 28 (1)		

(1) The use of surge suppressors increases the opening time on a scale of 1.1 to 1.5 for a varistor suppressor and on a scale of 1.5 to 3 for a transil diode suppressor.

AL.., AL..Z.., TAL.. Contactors

Technical Data

Screw Terminals

Built-in Auxiliary Contacts (1 stack) - Utilization Characteristics

Contactor types: AL.., TAL..	9	12	16	26	30	40
AL..Z.., TAL..Z..	9	12	16	—	—	—
Rated operational voltage U_e max. V	690					
Conventional free air thermal current I_{th} - $\theta \leq 40$ °C	A 16					
Rated frequency limits	Hz 25 ... 400					
Rated operational current I_e / AC-15 according to IEC 60947-5-1						
24-127 V 50/60 Hz	A 6					
220-240 V 50/60 Hz	A 4					
380-440 V 50/60 Hz	A 3					
500 V 50/60 Hz	A 2					
690 V 50/60 Hz	A 2					
Rated operational current I_e / DC-13 according to IEC 60947-5-1						
24 V d.c.	A / W 6 / 144					
48 V d.c.	A / W 2.8 / 134					
72 V d.c.	A / W 2 / 144					
125 V d.c.	A / W 1.1 / 138					
250 V d.c.	A / W 0.55 / 138					
Rated making capacity acc. to IEC 60947-5-1	10 x I_e / AC-15					
Rated breaking capacity acc. to IEC 60947-5-1	10 x I_e / AC-15					
Short-circuit protection gG type fuse	A 10					
Rated short-time withstand current I_{cw}						
for 1.0 s	A 100					
for 0.1 s	A 140					
Minimum switching capacity V / mA	17 / 5 (with a failure rate of 10^{-6} according to IEC 60947-5-4)					
Non-overlapping time between N.O. and N.C. contacts	ms ≥ 2					
Heat dissipation per pole at 6 A	W 0.10					

Electrical Durability for AC-15 Utilization Category

AC-15 utilization category according to IEC 60947-5-1 / EN 60947-5-1:

- making current: $10 \times I_e$ with $\cos \varphi = 0.7$ and U_e
- breaking current: I_e with $\cos \varphi = 0.4$ and U_e

This curve represents the electrical durability of the built-in or add-on auxiliary contacts in relation to the breaking current.

The curve has been drawn for resistive and inductive loads up to 690 V, 40 ... 60 Hz.

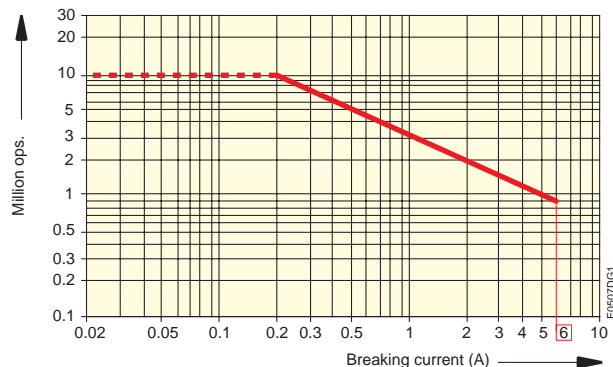

- AL.., AL..Z.. and TAL.. contactor built-in auxiliary contacts
- Auxiliary contact blocks CAL 5-.., CA 5-.., CA 5-..ST

AL..., AL..ST, AL..Z..., AL..Z..ST, TAL.. Contactors

Technical Data

Screw Terminals  and Spring Terminals 

Mounting Characteristics

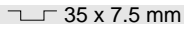
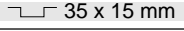
Contactor types:	AL..., AL..ST, AL..Z..., AL..Z..ST, TAL..
Mounting distances	The contactors can be assembled side by side, except TAL see table below
Fixing	
on DIN rail	 35 x 7.5 mm
according to IEC 715 and EN 50022 / EN 50023	 35 x 15 mm
by screws (not supplied)	2 x M4

Mounting Distance (for TAL)

d mm	D mm	Ambient temperature °C
5	20	≥ 20

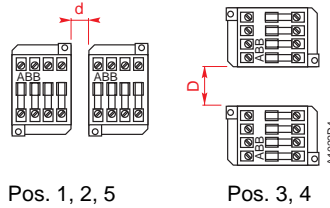

Conditions for Use

The contactor utilization conditions relating to the mounting position, ambient temperature and control voltage operating limits are summarized in the table below.

Contactors	Mounting position	Ambient temperature	Control voltage
AL9 ... AL40 / AL9..ST ... AL16..ST	1, 1 ± 30°, 2, 3, 4, 5 (1)	≤ 55 °C 55 ... 70 °C	0.85 ... 1.1 x U _c U _c
AL9Z ... AL16Z / AL9Z..ST ... AL16Z..ST	1, 2, 3, 4, 5	≤ 55 °C 55 ... 70 °C	0.85 ... 1.1 x U _c U _c
TAL9 ... TAL40	1, 1 ± 30°, 2, 3, 4, 5 (1)	≤ 55 °C	U _c min. - U _c max.

(1) (T)AL 9, (T)AL 16, (T)AL26-22-00 not allowed in position 5

Mounting Positions (see the above table for authorized positions)

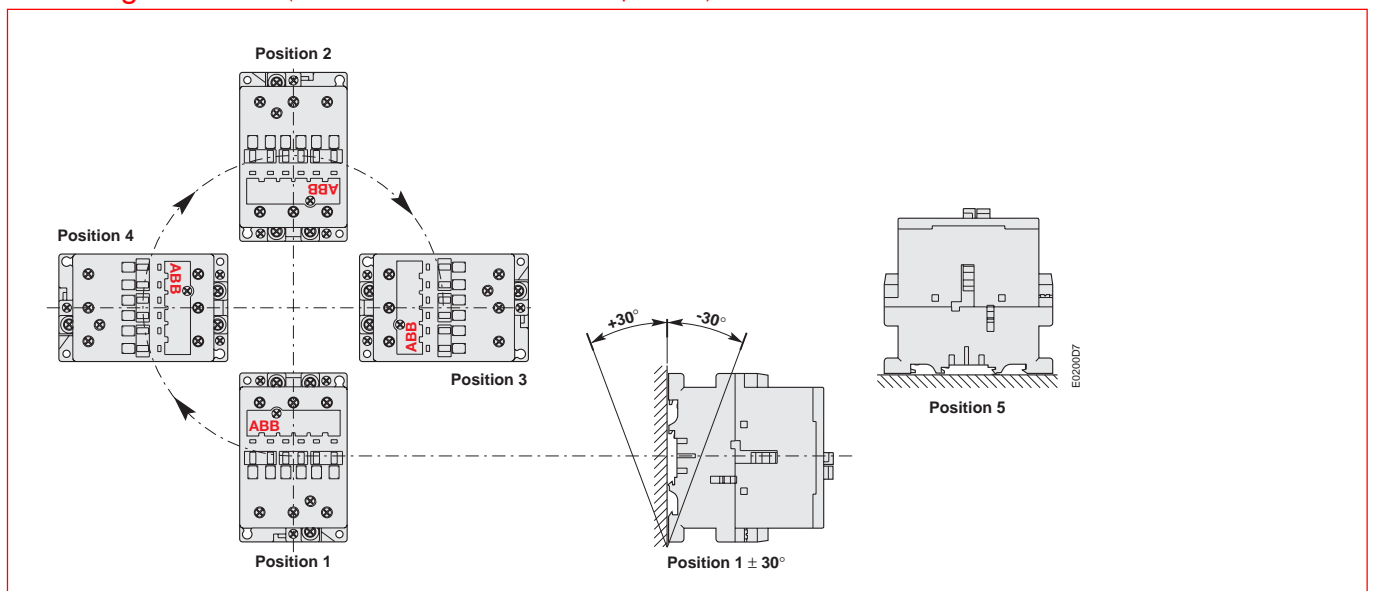











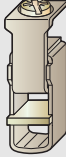

Please see page 10, 11 and 13 for accessory mounting compatibility.

AL.., AL..Z.., TAL.. Contactors

Technical Data

Screw Terminals

Connecting Characteristics

Contactor types: AL.., TAL..	9	12	16	26	30	40
AL..Z	9	12	16	—	—	—
Main terminals						
	with cable clamp			with double connector 2 x (5.6 x 6.5 mm)		
Connecting capacity (min. ... max.)						
Main conductors (poles)						
Rigid: solid ($\leq 4 \text{ mm}^2$)	 1 x mm ²	1 ... 4		1.5 ... 6	2.5 ... 16	
stranded ($\geq 6 \text{ mm}^2$)	 2 x mm ²	1 ... 4		1.5 ... 6	2.5 ... 16	
Flexible with cable end	 1 x mm ²	0.75 ... 2.5		0.75 ... 4	2.5 ... 10	
	 2 x mm ²	0.75 ... 2.5		0.75 ... 4	2.5 ... 10	
Bars or lugs	 L mm \leq l mm $>$	7.7 3.7		10 4.2	— —	— —
Auxiliary conductors						
Rigid solid (built-in auxiliary terminals + coil terminals)	 1 x mm ²	1 ... 4				
	 2 x mm ²	1 ... 4				
Flexible with cable end (built-in auxiliary terminals + coil terminals)	 1 x mm ²	0.75 ... 2.5				
	 2 x mm ²	0.75 ... 2.5				
Lugs						
– built-in aux.terminals	 L mm \leq l mm $>$	7.7 3.7		10 4.2	8 3.7	
– coil terminals	 L mm \leq l mm $>$	8 3.7				
Degree of protection acc. to IEC 60947-1 / EN 60947-1 and IEC 60529 / EN 60529	Protection against direct contact acc. to VDE 0106 - Part. 100					
– Main terminals	IP 20					
– Coil terminals	IP 20					
– Built-in auxiliary terminals	IP 20					
Screw terminals	(delivered in open position, screws of unused terminals must be tightened)					
Main terminals	(+, -) pozidriv 2 screws					
	M3.5			M4	M5	
Coil terminals	M3.5 (+, -) pozidriv 2 screws with cable clamp					
Built-in auxiliary terminals	(+, -) pozidriv 2 screws with cable clamp					
	M3.5			M4	M3.5	
Tightening torque						
Main pole terminals						
– recommended	Nm / lb.in	1.00 / 9		1.7 / 15	2.30 / 20	
– max.	Nm	1.20		2.20	2.60	
Coil terminals						
– recommended	Nm / lb.in	1.00 / 9				
– max.	Nm	1.20				
Built-in auxiliary terminals						
– recommended	Nm / lb.in	1.00 / 9		1.7 / 15	1.00 / 9	
– max.	Nm	1.20		2.20	1.20	
Terminal marking and positioning	 Page 43					









AL..ST, AL..Z..ST Contactors

Technical Data

Spring Terminals



Connecting Characteristics

Contactor types: AL..ST, AL..Z..ST	9	12	16	—	—	—
Main and coil terminals						
	spring terminals					
Connecting capacity (min. ... max.) Main conductors (poles) and coil conductors						
Rigid	 1 x mm ²  2 x mm ²	0.5 ... 4	0.5 ... 4			
Flexible	 1 x mm ² with isolated cable end	0.5 ... 1.5	0.5 ... 1.5			
Flexible	 2 x mm ² with non-isolated cable end	0.5 ... 2.5	0.5 ... 2.5			
Flexible	 1 x mm ² without cable end	0.5 ... 2.5	0.5 ... 2.5			
Flexible	 2 x mm ² without cable end	0.5 ... 2.5	0.5 ... 2.5			
Wire stripping length	mm	10				
Screwdriver type / size	mm	Flat / ø 3.0 or 3.5				
Degree of protection acc. to IEC 60947-1 / EN 60947-1 and IEC 60529 / EN 60529		Protection against direct contact acc. to VDE 0106 - Part. 100				
– Main terminals		IP 20				
– Coil terminals		IP 20				
Terminal marking and positioning		 Page 44				

Auxiliary Contact Blocks

Front Mounting
Spring Terminals



Technical Data

Types		1-pole CA 5-..ST, 4-pole CA 5-..ST
Compliance with standards		IEC 60947-5-1 and EN 60947-5-1
Certification and approvals		CE certification
Rated insulation voltage U_i according to IEC 60947-5-1	V	690
Rated operational voltage U_e	V a.c.	24 to 690
Conventional thermal current I_{th}	A	16
Rated operational current I_e according to IEC 60947-5-1 in a.c.		AC-15
	24 to 127 V	A 6
	220 to 240 V	A 4
	380 to 440 V	A 3
	500 to 690 V	A 2
		DC-13
in d.c.	24 V	A 6
	48 V	A 2.8
	72 V	A 1
	110 V	A 0.55
	125 V	A 0.55
	220 V	A 0.3
	250 V	A 0.3
Short circuit protection	A	10 (gG fuses)
Rated making capacity		10 x I_e AC-15
Rated breaking capacity		10 x I_e AC-15
Rated short-time withstand current I_{cw} 1 s	A	100
$\theta = 40\text{ °C}$ 0.1 s	A	140
Mechanical durability		
– millions of operating cycles		10
– max. mech. switching frequency	cycles/h	3600
Electrical durability		
– millions of operating cycles		see page 22
– max. elec. switching frequency	cycles/h	1200
Connecting capacity (min. ... max.)		
Rigid	1 x mm²	0.5 ... 4
	2 x mm²	0.5 ... 4
Flexible	1 x mm²	0.5 ... 1.5
with isolated cable end	2 x mm²	0.5 ... 1.5
Flexible	1 x mm²	0.5 ... 2.5
with non-isolated cable end	2 x mm²	0.5 ... 2.5
Flexible	1 x mm²	0.5 ... 2.5
without cable end	2 x mm²	0.5 ... 2.5
Wiring striping length	mm	10
Screwdriver type / size	mm	Flat / \varnothing 3.0 or 3.5
Degree of protection acc. to IEC 60529, IEC 60144, DIN 40050 and NFC 20-010		IP 20

AL.. Contactors

Electrical Durability

Electrical Durability for AC-1 Utilization Category $U_e \leq 690\text{ V}$. Ambient Temperature $\leq 55\text{ }^\circ\text{C}$

Switching non-inductive or slightly inductive loads. The breaking current I_b for AC-1 is equal to the rated operational current of the load.

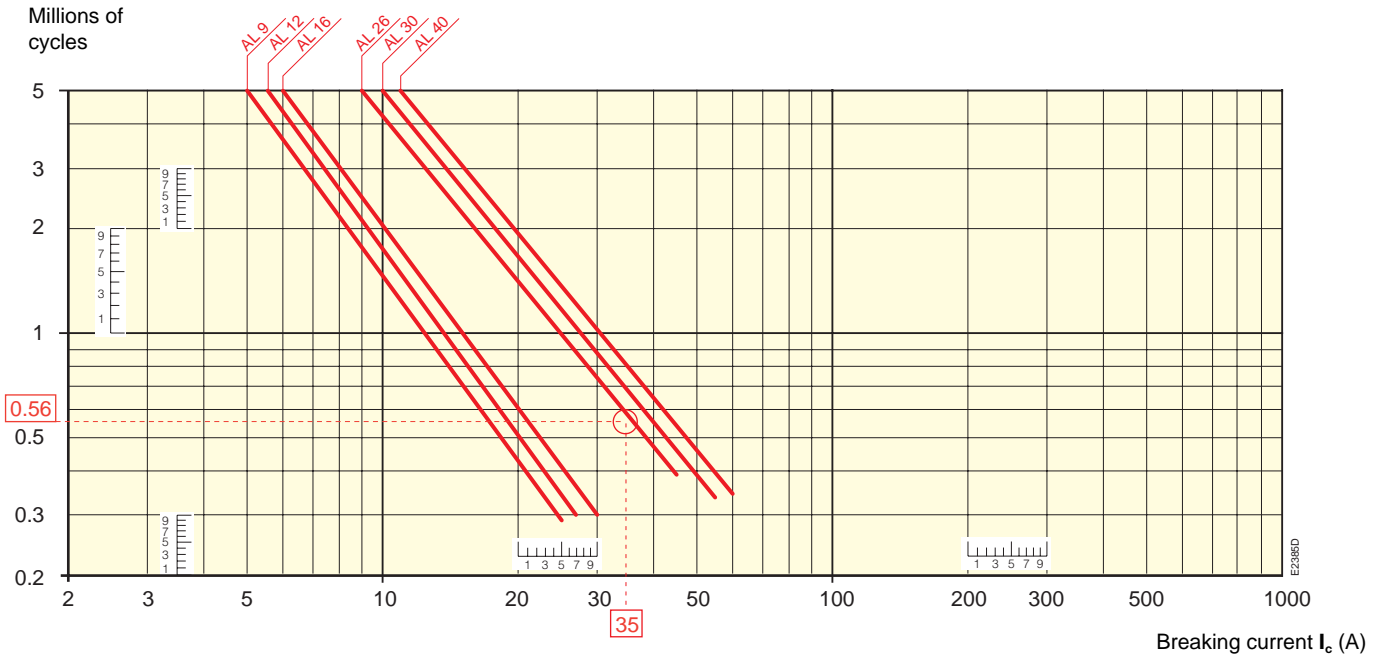

Example:

I_b / AC-1 = 35 A – Electrical durability required = 560 000 cycles.

Using the AC-1 curves above select the AL 26 contactor at intersection "O" (35 A / 560 000 cycles).

Electrical Durability for AC-3 Utilization Category - $U_e \leq 500\text{ V}$. Ambient Temperature $\leq 55\text{ }^\circ\text{C}$

Switching cage motors: starting and switching off running motors. The breaking current I_b for AC-3 is equal to the rated operational current I_e ($I_b = I_e = \text{motor full load current}$).

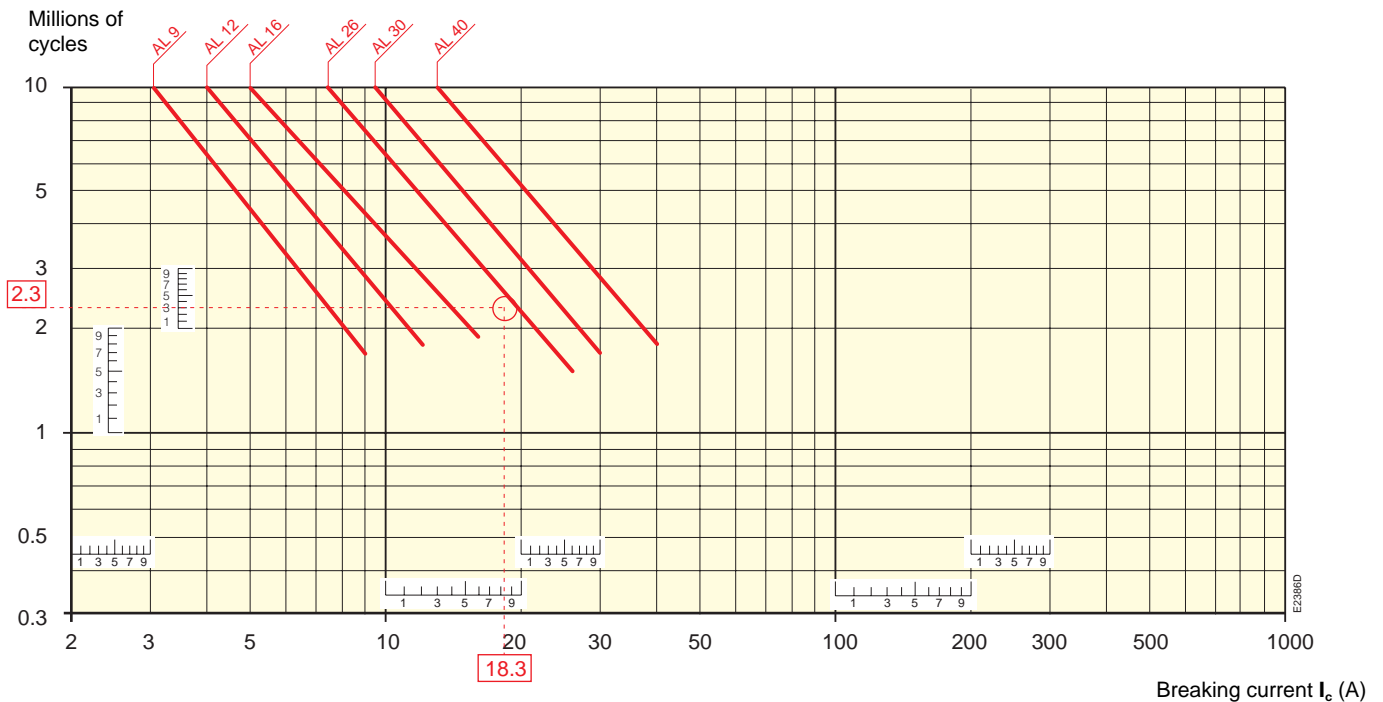

Example:

Motor power 9 kW for AC-3 - $U_e = 400\text{ V}$ utilization – Electrical durability required = 2.3 million cycles.

9 kW, 400 V corresponds to $I_e = 18.3\text{ A}$. For AC-3: $I_b = I_e$. Select the AL 26 contactor at intersection "O" (18.3 A / 2.3 million cycles) on the curves (AC-3 - $U_e \leq 500\text{ V}$).

NL.. Contactor Relays

d.c. Coil - Low Consumption



Operated Current AC-15, 400 V

Type (State coil voltage)

Rated current AC-15, **240 V**
690 V

Rated current DC-13 **24 V**
250 V

Coil consumption, pull-in
and holding at 20 °C

4-pole



A

A

A / W

A / W

W

	3 A	3 A	3 A
	NL 22E	NL 31E	NL 40E
	NL 22 E	NL 31 E	NL 40 E
	4	4	4
	2	2	2
	6 / 144	6 / 144	6 / 144
	0.3 / 75	0.3 / 75	0.3 / 75
	3	3	3

Auxiliary contacts

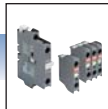

Front mounting 1 N.O. CA 5-10 1 N.C. CA 5-01 4-pole CA 5
Side mounting 1 N.O. + 1 N.C. CAL 5-11

Surge suppressors



Varistor RV5
Transil Diode RT5



Rated current AC-15, 400V

Type (State coil voltage)

8-pole



	3 A	3 A	3 A	3 A	3 A
	NL 44 E	NL 53 E	NL 62 E	NL 71 E	NL 80 E
	NL 44 E	NL 53 E	NL 62 E	NL 71 E	NL 80 E

NL.. Contactor Relays

d.c. Operated

Screw Terminals 



Application

NL.. contactor relays are used for switching auxiliary circuits and control circuits. Their low power consumption allows the direct control from transistor PLC outputs.

Description

The NL.. contactor relays are of the block type design.

The NL Z.. contactor relays are of the block type design with a very low coil consumption of 2.4 W.

The TNL.. contactor relays are of the block type design with a large coil operating range.

● Poles:

- 1-stack contactor relays: 4-pole.
- 2-stack contactor relays: 8-pole, with mechanically linked contact elements.
The width of 8-pole devices is identical to that of 4-pole devices; only the depth is increased.

● Control circuit: d.c. operated with solid core magnet circuit and low consumption coil. The coil must be energised from a d.c. supply and the polarity (+ and –) must be respected.

● Accessories: a wide range of accessories are available (⇨ see page 34).

Variant

● NL..ST version with spring terminals (page 30).

Contactor relays designation explanation

1) **NL Z 40 E**

Z = Version 2.4 W

2) **TNL 40 E**

T = Large voltage range

Blue = Standard Contactor relays features

Black = Different variations according to the application

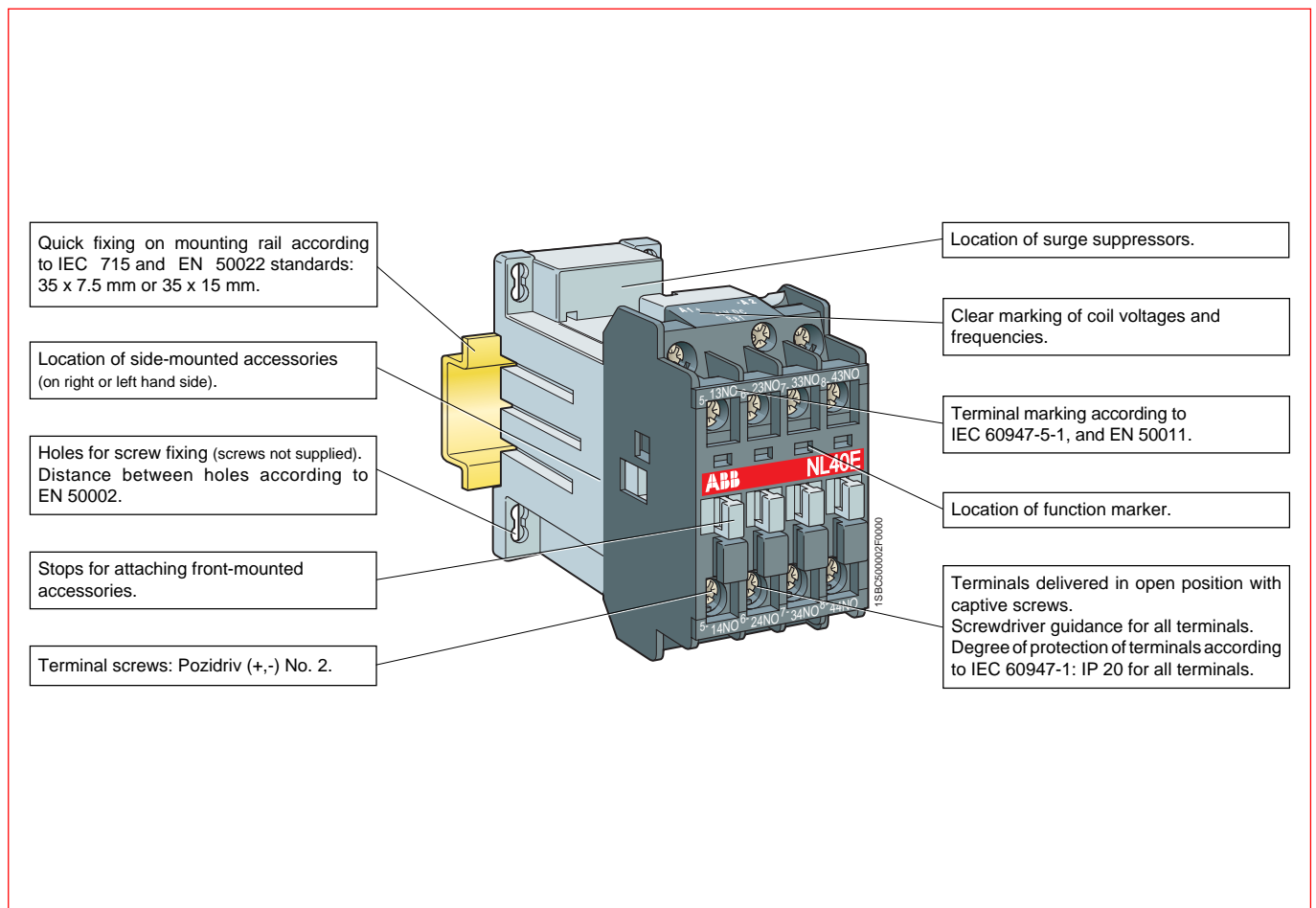

NL..ST Contactor Relays

d.c. Operated
Spring Terminals



Application

NL..ST, NL Z..ST and TNL..ST contactors are the spring terminal version of the NL-range.

The ST-range of contactor relays use ABB Entrec's proven spring terminal technology giving the following benefits:

- a fast connection on the front face, which saves labour time,
- vibration proof,
- no need to retighten the terminals saving maintenance labour time.

Description

- Poles and coil:
 - 1-stack contactor relays: 3-pole + coil terminals on the same stack.
 - 2-stack contactor relays: 7-pole + coil terminals on the first stack
The width of 7-pole devices is identical to that of 3-pole devices; only the depth is increased.
- Control circuit: d.c. operated with solid core magnet circuit and low coil consumption coil. The coil must be energised from a d.c. supply and the polarity (+ and -) must be respected.
- Accessories: a wide range of accessories are available (see page 36).
- Connection: the cables are connected via the front face with the possibility to use two different types of cables with different cross-sections.

Contactor relays designation explanation

- 1) **NL Z 30 E ST**
 - ST = Spring terminals
 - Z = Version 2.4 W
- 2) **TNL 30 E ST**
 - ST = Spring terminals
 - T = Large voltage range

Blue = Standard contactor relays features

Black = Different variations according to the application

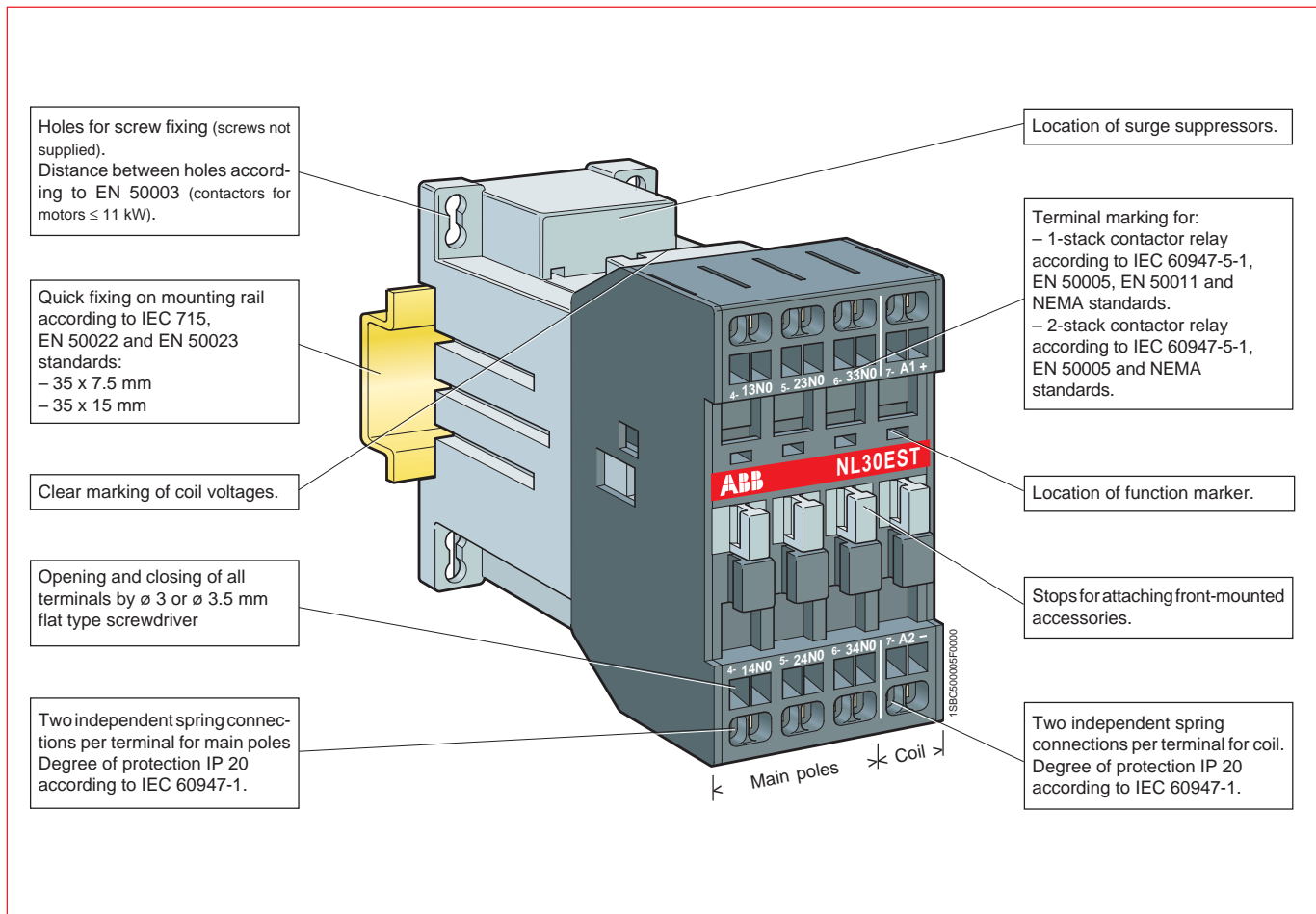

NL., NL..ST, NL Z., NL Z..ST Contactor Relays

d.c. Operated

Screw Terminals  and Spring Terminals 



NL 22 E





NL 80 E



NL Z 21 E ST

Ordering Details

Number of contacts		Type	Order code	Weight
1 st stack	2 nd stack			kg
		state coil voltage <input type="text"/> (see table below)	state coil voltage code <input type="text"/> <input type="text"/> (see table below)	Pack ^{ing} 1 piece

4-pole, 1-stack - 3 W consumption with screw terminals

2	2	-	-	-	-	NL 22 E <input type="text"/>	1SBH 14 3001 R <input type="text"/> <input type="text"/> 22	0.520
3	1	-	-	-	-	NL 31 E <input type="text"/>	1SBH 14 3001 R <input type="text"/> <input type="text"/> 31	0.520
4	-	-	-	-	-	NL 40 E <input type="text"/>	1SBH 14 3001 R <input type="text"/> <input type="text"/> 40	0.520

8-pole, 2-stack - 3 W consumption with screw terminals

4	-	-	4	-	-	NL 44 E <input type="text"/>	1SBH 14 3001 R <input type="text"/> <input type="text"/> 44	0.580
4	-	1	3	-	-	NL 53 E <input type="text"/>	1SBH 14 3001 R <input type="text"/> <input type="text"/> 53	0.580
4	-	2	2	-	-	NL 62 E <input type="text"/>	1SBH 14 3001 R <input type="text"/> <input type="text"/> 62	0.580
4	-	3	1	-	-	NL 71 E <input type="text"/>	1SBH 14 3001 R <input type="text"/> <input type="text"/> 71	0.580
4	-	4	-	-	-	NL 80 E <input type="text"/>	1SBH 14 3001 R <input type="text"/> <input type="text"/> 80	0.580

3-pole, 1-stack - 3 W consumption with spring terminals

2	1	-	-	-	-	NL 21 E ST <input type="text"/>	1SBH 14 3004 R <input type="text"/> <input type="text"/> 21	0.580
3	0	-	-	-	-	NL 30 E ST <input type="text"/>	1SBH 14 3004 R <input type="text"/> <input type="text"/> 30	0.580

4-pole, 1-stack - 2.4 W consumption with screw terminals

2	2	-	-	-	-	NL Z 22 E <input type="text"/>	1SBH 14 4001 R <input type="text"/> <input type="text"/> 22	0.520
3	1	-	-	-	-	NL Z 31 E <input type="text"/>	1SBH 14 4001 R <input type="text"/> <input type="text"/> 31	0.520
4	-	-	-	-	-	NL Z 40 E <input type="text"/>	1SBH 14 4001 R <input type="text"/> <input type="text"/> 40	0.520

3-pole, 1-stack - 2.4 W consumption with spring terminals

2	1	-	-	-	-	NL Z 21 E ST <input type="text"/>	1SBH 14 4004 R <input type="text"/> <input type="text"/> 21	0.580
3	0	-	-	-	-	NL Z 30 E ST <input type="text"/>	1SBH 14 4004 R <input type="text"/> <input type="text"/> 30	0.580

Coil voltages and codes NL.. and NL..ST

Voltage - U _c V d.c	Code
<input type="text"/>	<input type="text"/> <input type="text"/>
12	8 0
24	8 1
42	8 2
48	8 3
50	2 1
60	8 4
75	8 5
110	8 6
125	8 7
220	8 8
240	8 9
250	3 8

Coil voltages and codes NL Z.. and NL Z..ST

Voltage - U _c V d.c	Code
<input type="text"/>	<input type="text"/> <input type="text"/>
24	1 5
48	2 0

TNL.. and TNL..ST Contactor Relays



d.c. Operated

Screw Terminals  and Spring Terminals 



TNL 22 E



TNL 80 E



TNL 21 E ST

Ordering Details

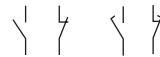
Number of contacts		Type	Order code	Weight
1 st stack	2 nd stack			kg
		state coil voltage <input type="text"/> (see table below)	state coil voltage code <input type="checkbox"/> <input type="checkbox"/> (see table below)	Pack ^{ing} 1 piece

4-pole, 1-stack - Large coil voltage with screw terminals

2	2	-	-	-	-	TNL 22 E <input type="text"/>	1SBH 14 3061 R <input type="checkbox"/> <input type="checkbox"/> 22	0.520
3	1	-	-	-	-	TNL 31 E <input type="text"/>	1SBH 14 3061 R <input type="checkbox"/> <input type="checkbox"/> 31	0.520
4	-	-	-	-	-	TNL 40 E <input type="text"/>	1SBH 14 3061 R <input type="checkbox"/> <input type="checkbox"/> 40	0.520

8-pole, 2-stack - Large coil voltage with screw terminals

4	-	-	4	-	-	TNL 44 E <input type="text"/>	1SBH 14 3061 R <input type="checkbox"/> <input type="checkbox"/> 44	0.580
4	-	2	2	-	-	TNL 62 E <input type="text"/>	1SBH 14 3061 R <input type="checkbox"/> <input type="checkbox"/> 62	0.580
4	-	4	-	-	-	TNL 80 E <input type="text"/>	1SBH 14 3061 R <input type="checkbox"/> <input type="checkbox"/> 80	0.580

3-pole, 1-stack - Large coil voltage with spring terminals

2	1	-	-	-	-	TNL 21 E ST <input type="text"/>	1SBH 14 3059 R <input type="checkbox"/> <input type="checkbox"/> 21	0.580
3	0	-	-	-	-	TNL 30 E ST <input type="text"/>	1SBH 14 3059 R <input type="checkbox"/> <input type="checkbox"/> 30	0.580

Note: For technical data and accessory compatibility on the TNL..ST range, please consult us.

Coil voltages and codes





Voltage - U _c V d.c	Code
17 ... 32	5 1
25 ... 45	5 2
36 ... 65	5 4
42 ... 78	5 8
50 ... 90	5 5
77 ... 143	6 2
90 ... 150	6 6
152 ... 264	6 8

Accessory Compatibility for NL.., NL Z.., TNL.. Contactor Relays

Screw Terminals

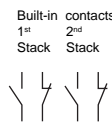
Compatibility between the Main Accessories

Many configurations are possible depending upon whether they are front-mounted or side-mounted.

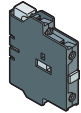
Contactor relay configuration  Types	Front-mounted accessories <div style="display: flex; justify-content: space-around; align-items: center;"> <div style="text-align: center;">  Auxiliary contact 1-pole CA 5-.. </div> <div style="text-align: center;">  Auxiliary contact 4-pole CA 5-.. </div> <div style="text-align: center;">  Auxiliary contact 1-pole CE 5-.. </div> </div>	Side-mounted accessory  Auxiliary contact 2-pole CAL 5-11
---------------------------------------------------------------------------------------------------------------------------------------------------	---------------------------------------------------------------------------------------------------------------------------------------------------------------------------------------------------------------------------------------------------------------------------------------------------------------------------------------------------------------------------------------------------------------------------------------------------------------------------------------------------------------------------------------------------------------------------------------------------------------------------------------------------------------------------------------------	------------------------------------------------------------------------------------------------------------------------------------------------------------------------------------

Position 1 ± 30° is not permitted

NL.. Contactor Relays

NL 22 E (5)	2 2	- -	1 to 4 x CA 5-..(4) or 1 x CA 5-.. (4-pole) (4)	-	-	or 1 x CAL 5-11 (3)
NL 31 E	3 1	- -				
NL 40 E	4 0	- -	1 to 4 x CA 5-..(1) or 1 x CA 5-.. (4-pole) (1)	or	1 to 2 x CE 5-.. (2)	or 1 x CAL 5-11 (3)
NL 44 E	4 0	0 4				
NL 53 E	4 0	1 3				
NL 62 E	4 0	2 2	-	-	-	-
NL 71 E	4 0	3 1				
NL 80 E	4 0	4 0				

NL Z.. and TNL.. Contactor Relays

NL Z 22 E (5) (6)	2 2	- -	1 to 2 x CA 5-..(1)	-	-	-
NL Z 31 E (6)	3 1	- -				
NL Z 40 E (6)	4 0	- -	1 to 2 x CA 5-..(1)	or	1 to 2 x CE 5-.. (2)	-
TNL 22 E (5)	2 2	- -	1 to 4 x CA 5-..(4) or 1 x CA 5-.. (4-pole) (4)			-
TNL 31 E	3 1	- -				
TNL 40 E	4 0	- -	1 to 4 x CA 5-..(1) or 1 x CA 5-.. (4-pole) (1)	or	1 to 2 x CE 5-.. (2)	-
TNL 44 E	4 0	0 4				
TNL 62 E	4 0	2 2	-	-	-	-
TNL 80 E	4 0	4 0				

(1) A maximum of 2 N.C. auxiliary contacts can be fitted in all positions except 5. In position 5 no N.C. auxiliary contacts are permitted.
 (2) CE 5-.. is not allowed in position 5.
 (3) With CAL5-11 the control voltage is limited to 0.9Uc ... 1.1Uc in all positions.

(4) A maximum of 2 N.C. auxiliary contacts can be fitted.
 (5) Mounting position 5 is not allowed.
 (6) Not allowed in position 1 ± 30°.

Conditions for Use: Please see page 40

Mounting Positions

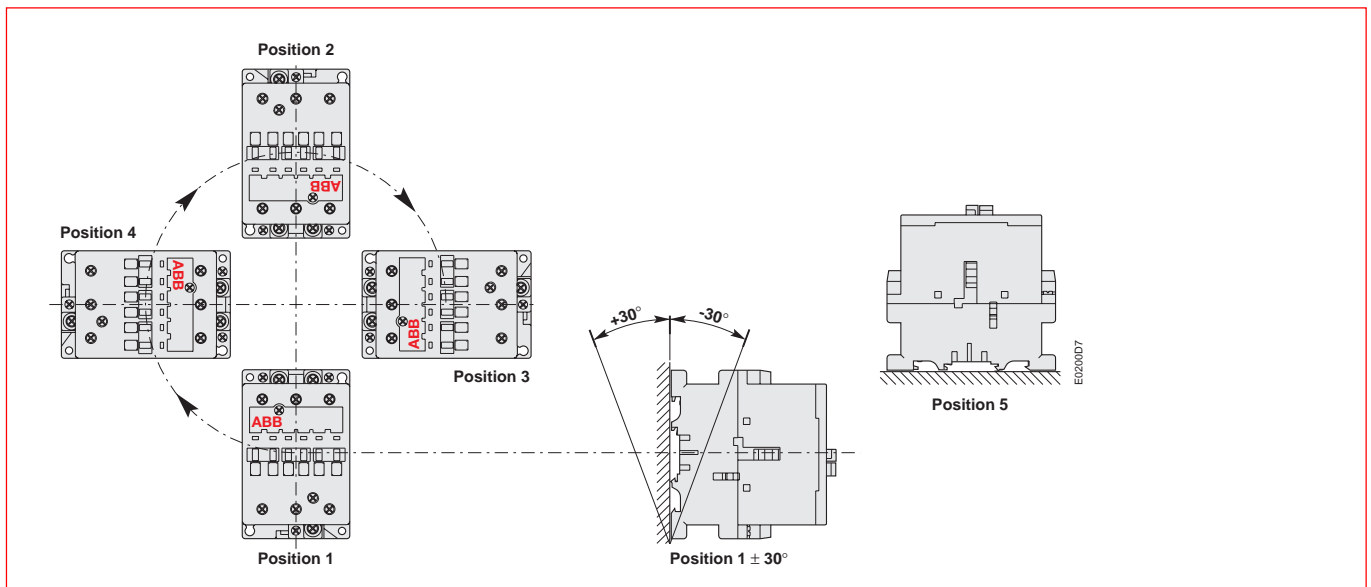

NL., NL Z., TNL.. Contactor Relays

Accessories

Screw Terminals

Ordering Details

Auxiliary Contact Blocks

Mounting on contactor relays	Positioning	Contacts	Type	Order Code	Pack ^{ing} piece	Weight kg
NL, NL Z, TNL	Front face	1 –	CA 5-10	1SBN 01 0010 R1010	10	0.014
		– 1	CA 5-01	1SBN 01 0010 R1001	10	0.014
NL, TNL	Front face	4 0	CA 5-40 N	1SBN 01 0040 R1240	2	0.060
		2 2	CA 5-22 N	1SBN 01 0040 R1222	2	0.060
NL, TNL	Side	1 1	CAL 5-11	1SBN 01 0020 R1011	2	0.050

See the accessory compatibility table page 33.

Electronic Timers

Mounting	Timing range	Supply voltage V	Type	Order Code	Pack ^{ing} piece	Weight kg
Independent	Direct	24 a.c. / d.c.	TE5S-24	1SBN 02 0010 R1001	1	0.080

Surge Suppressors

Mounting on contactor relays	Feature	Voltage range	Type	Order Code	Pack ^{ing} piece	Weight kg
NL, NL Z, TNL	Varistor	24 ... 50 V a.c. / d.c.	RV 5/50	1SBN 05 0010 R1000	2	0.015
		50 ... 133 V a.c. / d.c.	RV 5/133	1SBN 05 0010 R1001	2	0.015
		110 ... 250 V a.c. / d.c.	RV 5/250	1SBN 05 0010 R1002	2	0.015
		250 ... 440 V a.c. / d.c.	RV 5/440	1SBN 05 0010 R1003	2	0.015
NL, NL Z, TNL	Transil Diode	12 ... 32 V d.c.	RT 5/32	1SBN 05 0020 R1000	2	0.015
		25 ... 65 V d.c.	RT 5/65	1SBN 05 0020 R1001	2	0.015
		50 ... 90 V d.c.	RT 5/90	1SBN 05 0020 R1002	2	0.015
		77 ... 150 V d.c.	RT 5/150	1SBN 05 0020 R1003	2	0.015
		150 ... 264 V d.c.	RT 5/264	1SBN 05 0020 R1004	2	0.015

Function Marker

Mounting on contactor relays	Feature	Type	Order Code	Pack ^{ing} box	Weight kg
NL, NL Z, TNL	50 Pieces in a box	BA 5-50	1SBN 11 0000 R1000	1	0.017



CAL 5-11



CA 5-10



TE5S-24



RV 5/50





RT 5/32



BA 5-50

Accessory Compatibility for NL..ST and NL Z..ST Contactor Relays Spring Terminals

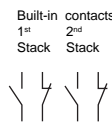
Compatibility between the Main Accessories

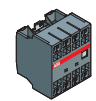
<p>Contactor relay configuration</p> <p style="text-align: center;">Built-in contacts 1st Stack 2nd Stack</p> <p>Types</p> 	<p>Front-mounted accessories</p> <div style="display: flex; justify-content: space-around; align-items: center;"> <div style="text-align: center;">  <p>Auxiliary contact 1-pole CA 5-..ST</p> </div> <div style="text-align: center;">  <p>Auxiliary contact 4-pole CA 5-..ST</p> </div> </div>
--------------------------------------------------------------------------------------------------------------------------------------------------------------------------------------------------------------------------------------------------	-------------------------------------------------------------------------------------------------------------------------------------------------------------------------------------------------------------------------------------------------------------------------------------------------------------------------------------------------------------------------------------------------------------------------------------------------------------------------------------------------

NL..ST Contactor Relays

NL 21 E ST	2 1	- -	1 to 4 x CA 5-..ST (1)	or	1 x CA 5-..ST (4-pole) (1)
NL 30 E ST	3 0	- -	1 to 4 x CA 5-..ST (1)	or	1 x CA 5-..ST (4-pole) (1)

NL Z..ST Contactor Relays

NL Z 21 E ST(2)	2 1	- -	1 to 2 x CA 5-..ST (1)		
NL Z 30 E ST(2)	3 0	- -	1 to 2 x CA 5-..ST (1)		

(1) A maximum of 2 N.C. auxiliary contacts can be fitted in all positions except 5. In position 5 no N.C. auxiliary contacts are permitted.
 (2) Not allowed in position 1 ± 30°.

Conditions for Use: Please see page 40

Mounting Positions

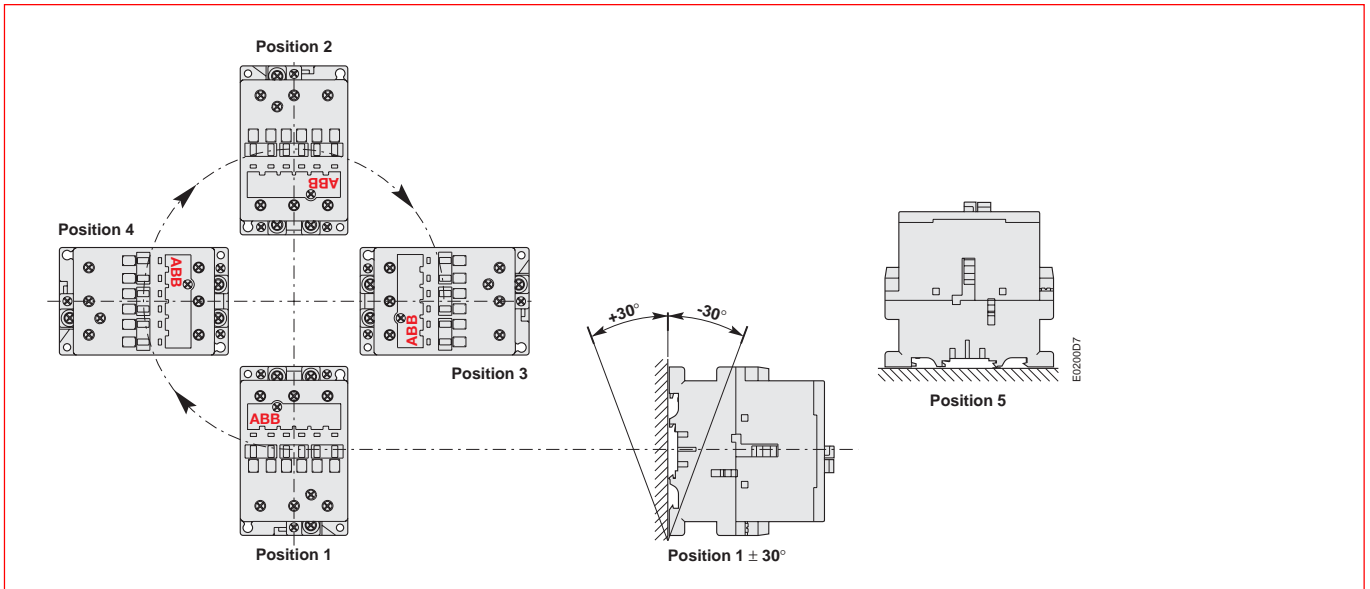

NL..ST and NL Z..ST Contactor Relays

Accessories

Spring Terminals



Ordering Details

Auxiliary Contact Blocks

Mounting on contactor relays	Positioning	Contacts	Type	Order Code	Pack ^{ing} piece	Weight kg
NL..ST, NL Z..ST	Front face	1 –	CA 5-10ST	1SBN 01 1419 R1010	10	0.016
		– 1	CA 5-01ST	1SBN 01 1419 R1001	10	0.016
		4 0	CA 5-40 NST	1SBN 01 1445 R1240	2	0.060
		2 2	CA 5-22 NST	1SBN 01 1445 R1222	2	0.060

See the accessory compatibility table page 35.

Surge Suppressors

Mounting on contactor relays	Feature	Voltage range	Type	Order Code	Pack ^{ing} piece	Weight kg
NL..ST NL Z..ST	Varistor	24 ... 50 V a.c. / d.c.	RV 5/50	1SBN 05 0010 R1000	2	0.015
		50 ... 133 V a.c. / d.c.	RV 5/133	1SBN 05 0010 R1001	2	0.015
		110 ... 250 V a.c. / d.c.	RV 5/250	1SBN 05 0010 R1002	2	0.015
		250 ... 440 V a.c. / d.c.	RV 5/440	1SBN 05 0010 R1003	2	0.015
N..ST NL Z..ST	Transil Diode	12 ... 32 V d.c.	RT 5/32	1SBN 05 0020 R1000	2	0.015
		25 ... 65 V d.c.	RT 5/65	1SBN 05 0020 R1001	2	0.015
		50 ... 90 V d.c.	RT 5/90	1SBN 05 0020 R1002	2	0.015
		77 ... 150 V d.c.	RT 5/150	1SBN 05 0020 R1003	2	0.015
		150 ... 264 V d.c.	RT 5/264	1SBN 05 0020 R1004	2	0.015

Function Marker

Mounting on contactor relays	Feature	Type	Order Code	Pack ^{ing} box	Weight kg
NL..ST, NL Z..ST	50 Pieces in a box	BA 5-50	1SBN 11 0000 R1000	1	0.017

Note:

Some accessories with screw terminals can be used with the ...ST contactor relays, these include TE5S Electronic Timer



CA 5-10ST



CA 5-40 NST



RV 5/50

RT 5/32



BA 5-50

NL..., NL Z..., TNL..., NL..ST, NL Z..ST

Contactor Relays

Technical Data

General Technical Data - Contactor relays with Screw Terminals

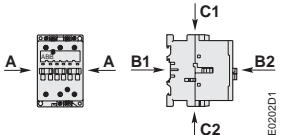

Contactor relay types	NL..., NL Z..., TNL..	
Rated insulation voltage U_i according to IEC 60947-4-1	V	690
according to UL/CSA	V	600
Rated impulse withstand voltage $U_{imp.}$	kV	8
Standards	Devices complying with international standards IEC 60947-5-1 / 60947-4-1 and European standards EN 60947-5-1 / 60947-4-1	
Certifications - Approvals	UL, CSA, CCC (in progress)	
Air temperature close to contactor – for operation in free air	°C	☞ " Conditions for use" , page 40, for control voltage limits, and authorized mounting positions -40 to +70 (55°C for TNL)
– for storage	°C	-60 to +80
Climatic withstand	acc. to IEC 60068-2-30 and 60068-2-11 - UTE C 63-100 specification II	
Operating altitude	m	≤ 3000
Shock withstand acc. IEC 60068-2-27 and EN 60068-2-27 Mounting position 1 (☞ page 40)	1/2 sinusoidal shock for 11 ms: no change in contact position	
	Shock direction	Open position Closed position
	A	10 g 20 g
	B1	5 g 15 g
	B2	10 g 15 g
	C1	8 g 20 g
	C2	8 g 14 g

General Technical Data - Contactor relays with Spring Terminals



Contactor relay types	NL..ST, NL Z..ST	
Rated insulation voltage U_i according to IEC 60947-4-1	V	690
Rated impulse withstand voltage $U_{imp.}$	kV	6
Standards	Devices complying with international standards IEC 60947-5-1 / 60947-4-1 and European standards EN 60947-5-1 / 60947-4-1	
Air temperature close to contactor – for operation in free air	°C	☞ " Conditions for use" , page 40, for control voltage limits, and authorized mounting positions -40 to +70
– for storage	°C	-60 to +80
Climatic withstand	acc. to IEC 60068-2-30 and 60068-2-11 - UTE C 63-100 specification II	
Operating altitude	m	≤ 3000

NL., NL Z., TNL., NL..ST, NL Z..ST Contactor Relays

Technical Data

Screw Terminals and Spring Terminals

Contact Utilization Characteristics

Contactor relay types	NL., NL Z., TNL., NL..ST, NL Z..ST	
Rated operational voltage U_e max.	V	690
Rated frequency limits	Hz	25 ... 400
Conventional free-air thermal current I_{th} according to IEC 60947-5-1, open contactors $\theta \leq 40^\circ\text{C}$	A	16
Rated operational current I_e / AC-15 according to IEC 60947-5-1 / UL508 (1) / CSA 22.2 (1)		
24-127 V 50/60 Hz	A	6
230-240 V 50/60 Hz	A	4
400-415 V 50/60 Hz	A	3
500 V 50/60 Hz	A	2
690 V 50/60 Hz	A	2
Rated operational current I_e / DC-13 according to IEC 60947-5-1 / UL508 (1) / CSA 22.2 (1)		
24 V d.c.	A/W	6 / 144
48 V d.c.	A/W	2.8 / 134
72 V d.c.	A/W	1 / 72
125 V d.c.	A/W	0.55 / 69
250 V d.c.	A/W	0.3 / 75
Rated making capacity according to IEC 60947-5-1		$10 \times I_e$ / AC-15
Rated breaking capacity according to IEC 60947-5-1		$10 \times I_e$ / AC-15
Short-circuit protection $U_e \leq 500$ V a.c. - gG type fuse	A	10
Rated short-time withstand current I_{cw} at 40°C ambient temp., in free air, from a cold state		
1.0 s	A	100
0.1 s	A	140
Minimum switching capacity (1) with a failure rate of 10^{-6} acc. IEC 60947-5-4		17 V / 5 mA
Heat dissipation per pole at 6 A (1)	W	0.10
Max. electric switching frequency	cycles/h	1200
Mechanical durability		
– millions of operating cycles		> 20
– max. mechanical switching frequency	cycles/h	6000

(1) Screw terminal contactors only.

Electrical Durability for AC-15 Utilization Category

AC-15 utilization category according to IEC 60947-5-1 / EN 60947-5-1:

- making current: $10 \times I_e$ with $\cos \varphi = 0.7$ and U_e
- breaking current: I_e with $\cos \varphi = 0.4$ and U_e

This curve represents the electrical durability of the contactor relays, in relation to the breaking current.

The curve has been drawn for resistive and inductive loads up to 690 V, 40 ... 60 Hz.

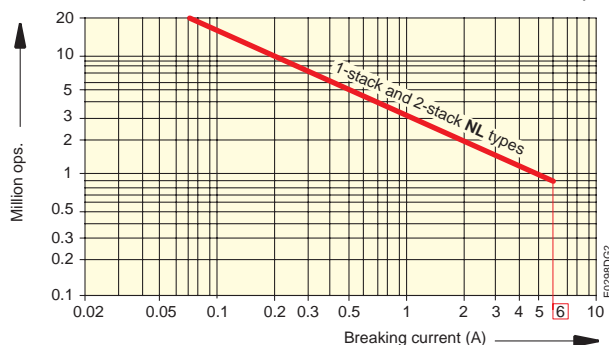

– NL., NL..ST, NL Z., NL Z..ST and TNL.. contactor relays.

NL.., NL..ST, NL Z.., NL Z..ST, TNL.. Contactor Relays

Technical Data

Screw Terminals  and Spring Terminals 

Magnet System Characteristics for NL... and NL...ST Contactor Relays

Contactor relay types		NL.. and NL..ST - 3 W
Rated control circuit voltage U_c	V d.c.	12 ... 250
Coil operating limits acc. to IEC 60947-5-1:		See conditions for use page 40
Drop-out voltage in % of U_c		roughly 10 ... 30 %
Coil consumption - Average values		
- pull-in value	W	3.0
- holding value	W	3.0
Operating time		
between coil energization and:		
- N.O. contact closing	ms	50 ... 100
- N.C. contact opening	ms	20 ... 70
between coil de-energization and:		
- N.O. contact opening	ms	10 ... 17 ⁽¹⁾
- N.C. contact closing	ms	16 ... 27 ⁽¹⁾

(1) the use of surge suppressors increases the opening time on a scale of 1.1 to 1.5 for a varistor suppressor and on a scale of 1.5 to 3 for a transil diode suppressor.

Magnet System Characteristics for NL Z.. and NL Z..ST Contactor Relays

Contactor relay types		NL Z.. and NL Z..ST - 2.4 W
Rated control circuit voltage U_c	V d.c.	24 and 48
Coil operating limits acc. to IEC 60947-5-1:		See conditions for use page 40
Drop-out voltage in % of U_c		roughly 10 ... 30 %
Coil consumption - Average values		
- pull-in value	W	2.4
- holding value	W	2.4
Operating time		
between coil energization and:		
- N.O. contact closing	ms	50 ... 100
- N.C. contact opening	ms	20 ... 70
between coil de-energization and:		
- N.O. contact opening	ms	10 ... 17 ⁽¹⁾
- N.C. contact closing	ms	16 ... 27 ⁽¹⁾

(1) the use of surge suppressors increases the opening time on a scale of 1.1 to 1.5 for a varistor suppressor and on a scale of 1.5 to 3 for a transil diode suppressor.

Magnet System Characteristics for TNL.. Contactor Relays

Contactor relay types		TNL..
Rated control circuit voltage U_c	V d.c.	9 ... 264
Coil operating limits acc. to IEC 60947-5-1:		See conditions for use page 40
Drop-out voltage in % of U_c		roughly 20 ... 35 %
Coil consumption - at pull-in and holding		
- U_c max	W	8.5
- U_c min	W	2.5
- U_c	W	5
Operating time		
between coil energization and:		
- N.O. contact closing	ms	50 ... 100
- N.C. contact opening	ms	20 ... 70
between coil de-energization and:		
- N.O. contact opening	ms	10 ... 17 ⁽¹⁾
- N.C. contact closing	ms	16 ... 27 ⁽¹⁾



(1) the use of surge suppressors increases the opening time on a scale of 1.1 to 1.5 for a varistor suppressor and on a scale of 1.5 to 3 for a transil diode suppressor.

NL..., NL Z..., NL..ST, NL Z..ST, TNL Contactor Relays

Technical Data

Screw Terminals  & Spring Terminals 

Mounting Characteristics

Contactor relay types	NL..., NL Z..., NL..ST, NL Z..ST, TNL
Mounting distances	The contactors can be assembled side by side, except TNL see table below
Fixing	
on DIN rail according to IEC 715 and EN 50022	 35 x 7.5 mm
	 35 x 15 mm
by screws (not supplied)	2 x M4

Mounting Distance (for TNL)

d mm	D mm	Ambient temperature °C
5	20	≥ 20

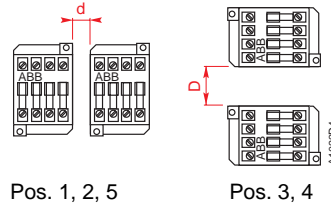

Conditions for Use

The contactor utilization conditions relating to the mounting position, ambient temperature and control voltage operating limits are summarized in the table below.

Contactor relay types	Mounting position	Ambient temperature	Control voltage
NL..., NL..ST	1, 1 ± 30°, 2, 3, 4, 5 (1)	≤ 55 °C 55 ... 70 °C	0.85 ... 1.1 x U _c U _c
NL Z..., NL Z..ST	1, 2, 3, 4, 5 (1)	≤ 55 °C 55 ... 70 °C	0.85 ... 1.1 x U _c U _c
TNL...	1, 1 ± 30°, 2, 3, 4, 5 (1)	≤ 55 °C	U _c min U _c max

(1) (T)NL 22E and NL Z 22E not allowed in position 5

Mounting Positions (see the above table for authorized positions)

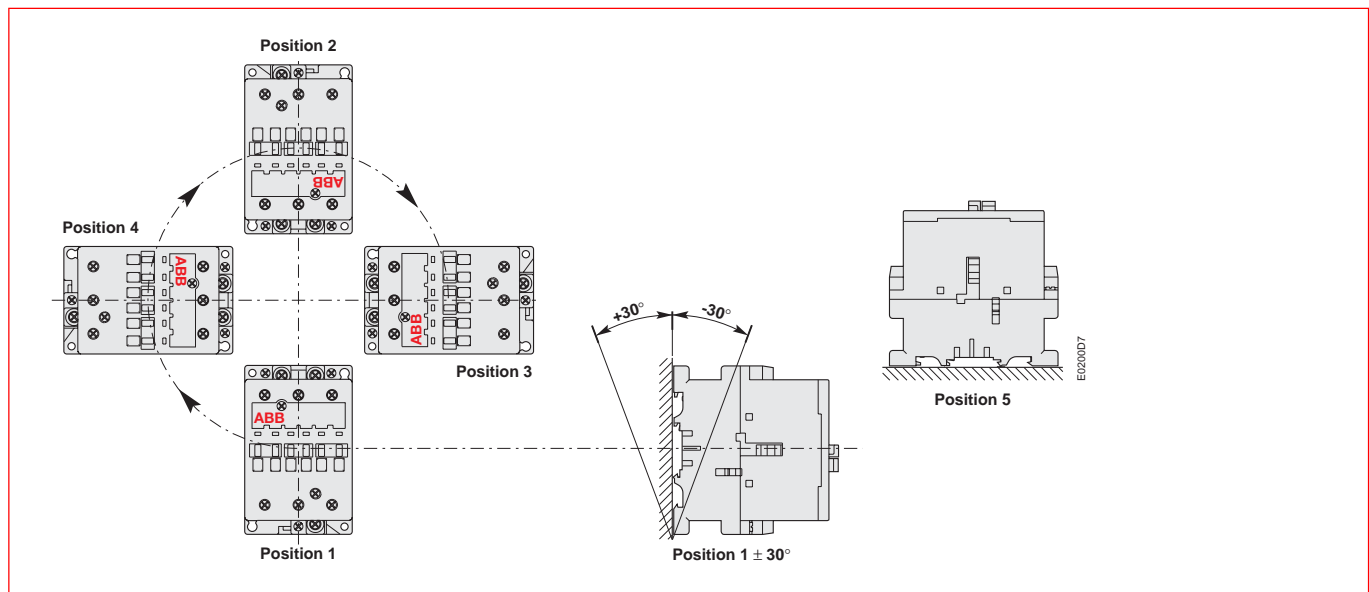

For accessory mounting compatibility (Please see pages 33 and 35)



































NL..., NL Z..., TNL... Contactor Relays

Technical Data

Screw Terminals



Connecting Characteristics

Contactor relay types:	NL..., NL Z..., TNL...						
Main terminals	 <p>with cable clamp</p>						
Connecting capacity (min. ... max.)							
Main conductors (poles)							
Rigid	<table border="0"> <tr> <td></td> <td>1 x mm²</td> <td>1 ... 4</td> </tr> <tr> <td></td> <td>2 x mm²</td> <td>1 ... 4</td> </tr> </table>		1 x mm ²	1 ... 4		2 x mm ²	1 ... 4
	1 x mm ²	1 ... 4					
	2 x mm ²	1 ... 4					
Flexible with cable end	<table border="0"> <tr> <td></td> <td>1 x mm²</td> <td>0.75 ... 2.5</td> </tr> <tr> <td></td> <td>2 x mm²</td> <td>0.75 ... 2.5</td> </tr> </table>		1 x mm ²	0.75 ... 2.5		2 x mm ²	0.75 ... 2.5
	1 x mm ²	0.75 ... 2.5					
	2 x mm ²	0.75 ... 2.5					
Bars or lugs	<table border="0"> <tr> <td></td> <td>L mm ≤</td> <td>7.7</td> </tr> <tr> <td></td> <td>l mm ></td> <td>3.7</td> </tr> </table>		L mm ≤	7.7		l mm >	3.7
	L mm ≤	7.7					
	l mm >	3.7					
Auxiliary conductors							
Rigid solid (built-in auxiliary terminals + coil terminals)	<table border="0"> <tr> <td></td> <td>1 x mm²</td> <td>1 ... 4</td> </tr> <tr> <td></td> <td>2 x mm²</td> <td>1 ... 4</td> </tr> </table>		1 x mm ²	1 ... 4		2 x mm ²	1 ... 4
	1 x mm ²	1 ... 4					
	2 x mm ²	1 ... 4					
Flexible with cable end (built-in auxiliary terminals + coil terminals)	<table border="0"> <tr> <td></td> <td>1 x mm²</td> <td>0.75 ... 2.5</td> </tr> <tr> <td></td> <td>2 x mm²</td> <td>0.75 ... 2.5</td> </tr> </table>		1 x mm ²	0.75 ... 2.5		2 x mm ²	0.75 ... 2.5
	1 x mm ²	0.75 ... 2.5					
	2 x mm ²	0.75 ... 2.5					
Lugs							
– built-in aux. terminals	<table border="0"> <tr> <td></td> <td>L mm ≤</td> <td>7.7</td> </tr> <tr> <td></td> <td>l mm ></td> <td>3.7</td> </tr> </table>		L mm ≤	7.7		l mm >	3.7
	L mm ≤	7.7					
	l mm >	3.7					
– coil terminals	<table border="0"> <tr> <td></td> <td>L mm ≤</td> <td>8</td> </tr> <tr> <td></td> <td>l mm ></td> <td>3.7</td> </tr> </table>		L mm ≤	8		l mm >	3.7
	L mm ≤	8					
	l mm >	3.7					
Degree of protection acc. to IEC 60947-1 / EN 60947-1 and IEC 60529 / EN 60529	Protection against direct contact acc. to VDE 0106 - Part. 100						
– Main terminals	IP 20						
– Coil terminals	IP 20						
– Built-in auxiliary terminals	IP 20						
Screw terminals	(delivered in open position, screws of unused terminals must be tightened)						
Main terminals	M3.5 (+,-) pozidriv 2 screws						
Coil terminals	M3.5 (+,-) pozidriv 2 screws with cable clamp						
Built-in auxiliary terminals	M3.5 (+,-) pozidriv 2 screws with cable clamp						
Tightening torque							
Main pole terminals							
– recommended	Nm / lb.in	1.00 / 9					
– max.	Nm	1.20					
Coil terminals							
– recommended	Nm / lb.in	1.00 / 9					
– max.	Nm	1.20					
Built-in auxiliary terminals							
– recommended	Nm / lb.in	1.00 / 9					
– max.	Nm	1.20					
Terminal marking and positioning	 Page 45						

NL..ST, NL Z..ST Contactor Relays

Technical Data

Spring Terminals



Connecting Characteristics

Contactor relay types:

NL.. ST, NL Z..ST

Main and coil terminals







spring terminals



Connecting capacity (min. ... max.)

Main and coil conductors

Rigid  1 x mm² 0.5 ... 4
 2 x mm² 0.5 ... 4

Flexible  1 x mm² 0.5 ... 1.5
with isolated cable end  2 x mm² 0.5 ... 1.5

Flexible  1 x mm² 0.5 ... 2.5
with non-isolated cable end  2 x mm² 0.5 ... 2.5

Flexible  1 x mm² 0.5 ... 2.5
without cable end  2 x mm² 0.5 ... 2.5

Wire stripping length mm 10

Screwdriver type / size mm Flat / ø 3.0 or ø 3.5

Degree of protection acc. to IEC 60947-1 / EN 60947-1 and IEC 60529 / EN 60529

Protection against direct contact acc. to VDE 0106 - Part. 100

– Main terminals

IP 20

– Coil terminals

IP 20

Terminal marking and positioning

 Page 46

Terminal Marking and Positioning

AL 9 ... AL 40 Contactors Screw Terminals



3-pole Contactors - d.c. operated

Standard devices without addition of auxiliary contacts

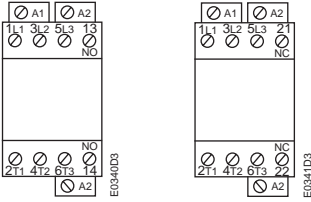

AL9 ... AL40-30-10
AL9 Z ... AL16 Z-30-10
TAL9 ... TAL40-30-10

AL9 ... AL40-30-01
AL9 Z ... AL16 Z-30-01
TAL9 ... TAL40-30-01

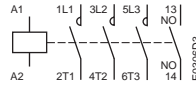

AL9 ... AL40-30-10
AL9 Z ... AL16 Z-30-10
TAL9 ... TAL40-30-10

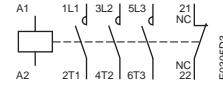

AL9 ... AL40-30-01
AL9 Z ... AL16 Z-30-01
TAL9 ... TAL40-30-01

Standard devices with factory mounted auxiliary contacts

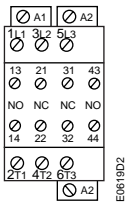

AL9 ... AL40-30-22



AL9 ... AL40-30-22

Other possible contact combinations with auxiliary contacts added by the user

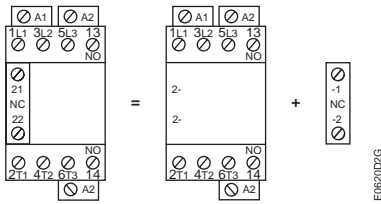

Combination 11 = AL9 ... AL40-30-10 + CA5-01
= AL9 Z ... AL16 Z-30-10 + CA5-01
= TAL9 ... TAL40-30-10 + CA5-01

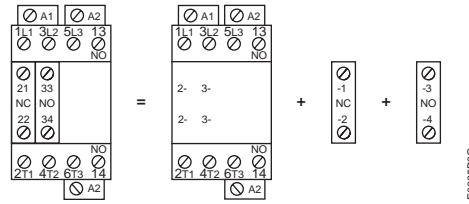

Combination 21 = AL9 ... AL40-30-10 + CA5-01 + CA5-10
= AL9 Z ... AL16 Z-30-10 + CA5-01 + CA5-10
= TAL9 ... AL40-30-10 + CA5-01 + CA5-10

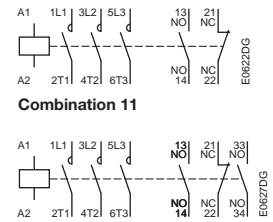

Combination 11

Combination 21

4-pole Contactors - d.c. operated

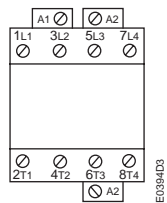

AL9 ... AL26-40-00
TAL9 ... TAL26-40-00

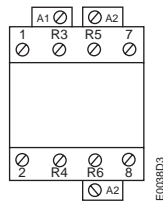

AL9 ... AL26-22-00
TAL9 ... TAL26-22-00

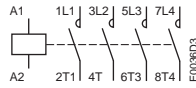

AL9 ... AL26-40-00
TAL9 ... TAL26-40-00

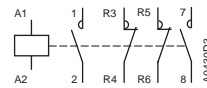

AL9 ... AL26-22-00
TAL9 ... TAL26-22-00

Terminal Marking and Positioning

AL..ST and AL Z..ST

Spring Terminals

3-pole Contactors - d.c. operated

Standard devices without addition of auxiliary contacts

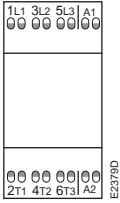

AL9 ... AL16-30-00ST
AL9 Z ... AL16 Z-30-00ST

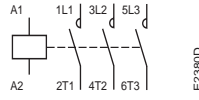

AL9 ... AL16-30-00ST
AL9 Z ... AL16 Z-30-00ST

Other possible combinations with auxiliary contacts added by the user.

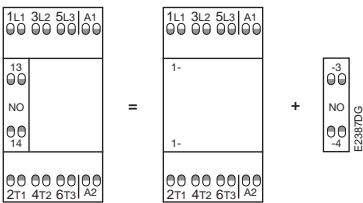

Combination 10 = AL9 ... AL16-30-00ST + CA5-10ST
AL9 Z ... AL16 Z-30-00ST + CA5-10ST

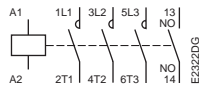

Combination 10

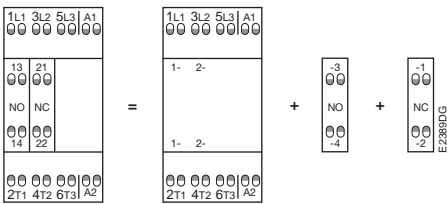

Combination 11 = AL9 ... AL16-30-00ST + CA5-10ST + CA5-01ST
AL9 Z ... AL16 Z-30-00ST + CA5-10ST + CA5-01ST

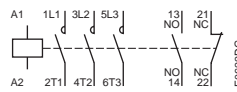

Combination 11

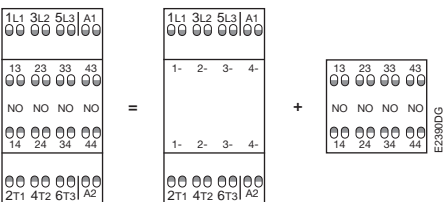

Combination 40 = AL9 ... AL16-30-00ST + CA5-40EST

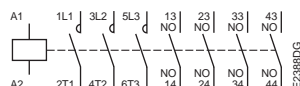

Combination 40

Terminal Marking and Positioning

NL.. Contactor Relays

Screw Terminals

NL.. Contactor Relays - d.c. operated

Standard devices without addition of auxiliary contacts

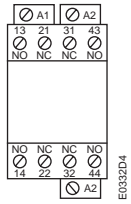

NL 22 E
NL Z 22 E
TNL 22 E

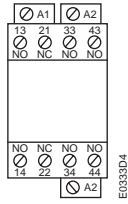

NL 31 E
NL Z 31 E
TNL 31 E

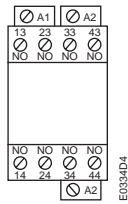

NL 40 E
NL Z 40 E
TNL 40 E

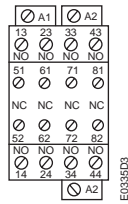

NL 44 E
TNL 44 E

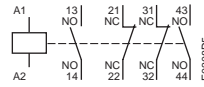

NL 22 E
NL Z 22 E
TNL 22 E

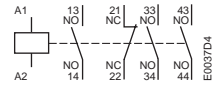

NL 31 E
NL Z 31 E
TNL 31 E

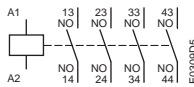

NL 40 E
NL Z 40 E
TNL 40 E

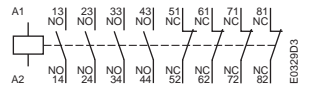

NL 44 E
TNL 44 E

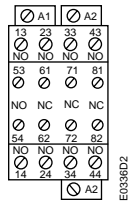

NL 53 E

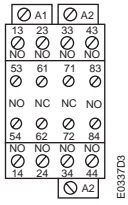

NL 62 E
TNL 62 E

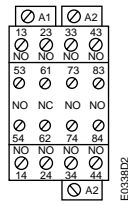

NL 71 E

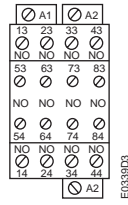

NL 80 E
TNL 80 E

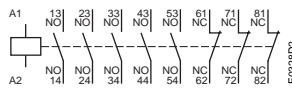

NL 53 E

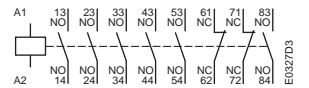

NL 62 E
TNL 62 E



NL 71 E

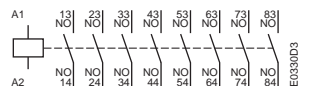

NL 80 E
TNL 80 E

Other possible contact combinations with auxiliary contacts added by the user

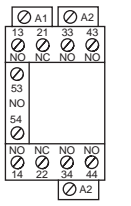

Combination 41 E

=
=
=

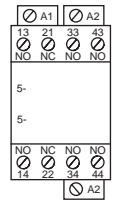

NL 31 E
NL Z 31 E
TNL 31 E

+
+



CA5-10

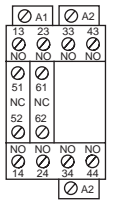

Combination 42 E

=
=

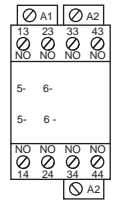

NL 40 E
NL Z 40 E
TNL 40 E

+
+



CA5-01

+
+



CA5-01

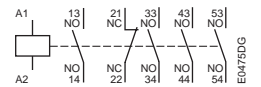

Combination 41 E

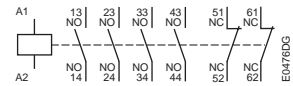

Combination 42 E

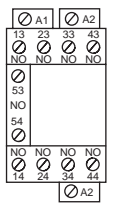

Combination 50 E

=
=
=

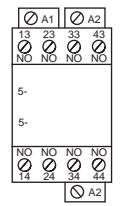

NL 40 E
NL Z 40 E
TNL 40 E

+
+



CA5-10

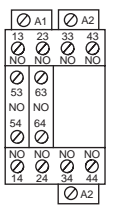

Combination 60 E

=
=

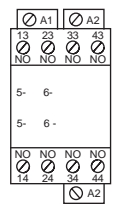

NL 40 E
NL Z 40 E
TNL 40 E

+
+



CA5-10

+
+



CA5-10

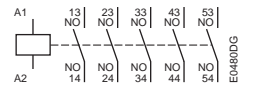

Combination 50 E

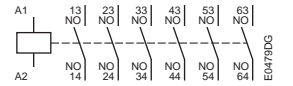

Combination 60 E

Terminal Marking and Positioning

NL..ST and NL Z..ST

Spring Terminals

Contactor Relays - d.c. operated

Standard devices without addition of auxiliary contacts

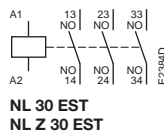
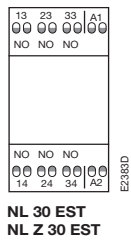
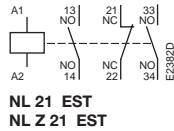
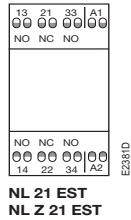

Other possible combinations with auxiliary contacts added by the user.

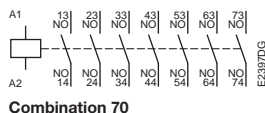
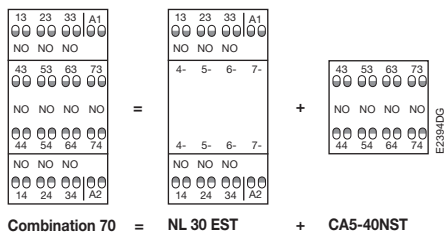
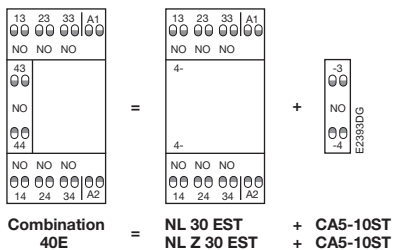
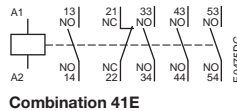
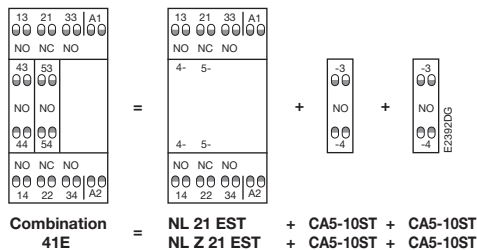
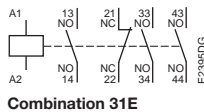
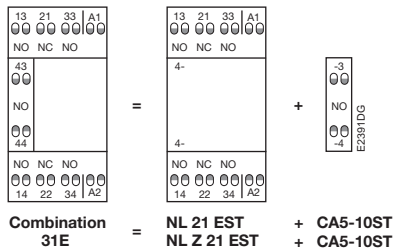

AL 9 ... 16, AL..Z., TAL 9 ... 16, 3 and 4-pole NL., NL Z., TNL.. Contactor Relays



Screw Terminals

Dimensions (in mm)

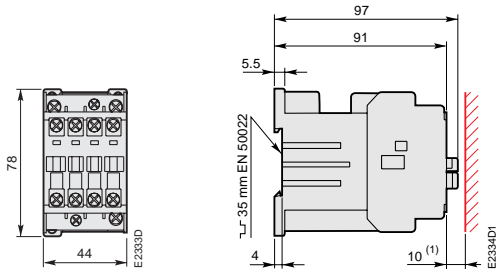

**AL 9 ... AL 16, AL..Z.
TAL 9 ... TAL 16
NL., NL Z., TNL..**

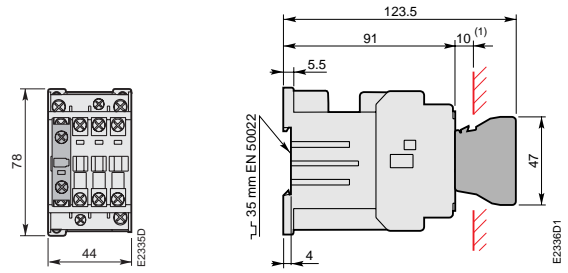

**AL 9 ... AL 16, AL..Z.
TAL 9 ... TAL 16
NL., NL Z., TNL..
+ CA 5 front-mounted 1-pole auxiliary contact block**

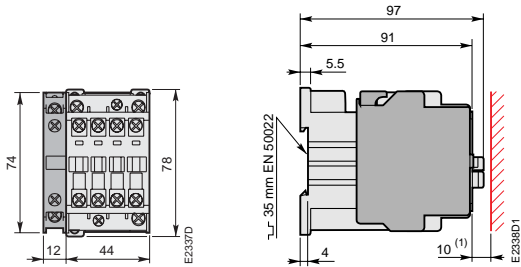

**AL 9 ... AL 16
TAL 9 ... TAL 16
NL., TNL..
+ CAL 5 side-mounted 2-pole auxiliary contact block**

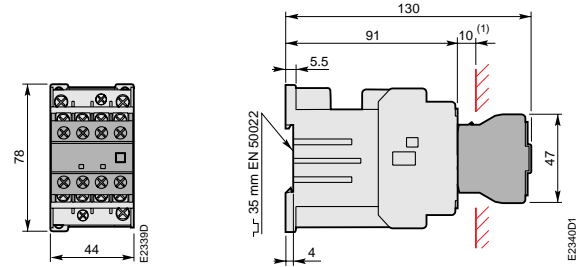

**AL 9 ... AL 16
TAL 9 ... TAL 16
NL., TNL..
+ CA 5 front-mounted 4-pole auxiliary contact block**

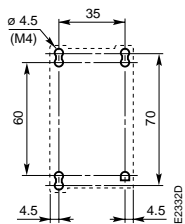

**AL 9 ... AL 16, AL..Z.
TAL 9 ... TAL 16
NL., NL Z., TNL..
drilling plan**

(1) Note: No recommended distance to earth is applicable to "NL., TNL.." contactor relays.

AL 9 ... AL 16, AL Z..., TAL 9 ... TAL 16, 3 and 4-pole Contactors



Screw Terminals

Dimensions (in mm)

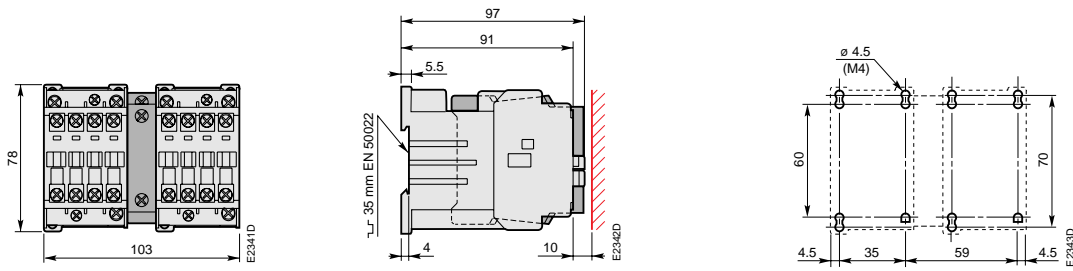

AL 9 ... AL 16
TAL 9 ... TAL 16
+ VE 5-1 electrical and mechanical interlock unit

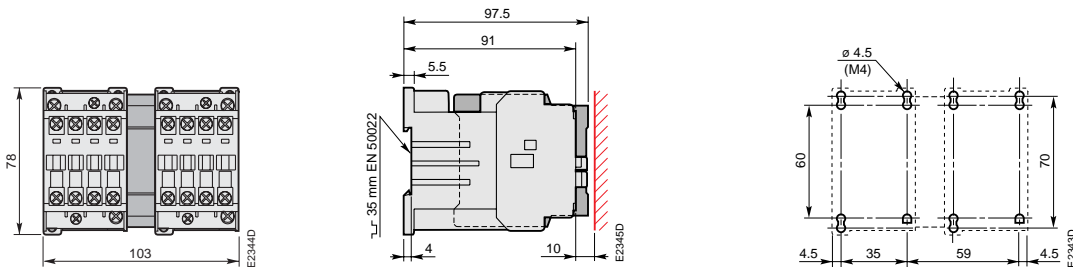

AL 9 ... AL 16
TAL 9 ... TAL 16
+ VM 5-1 mechanical interlock unit

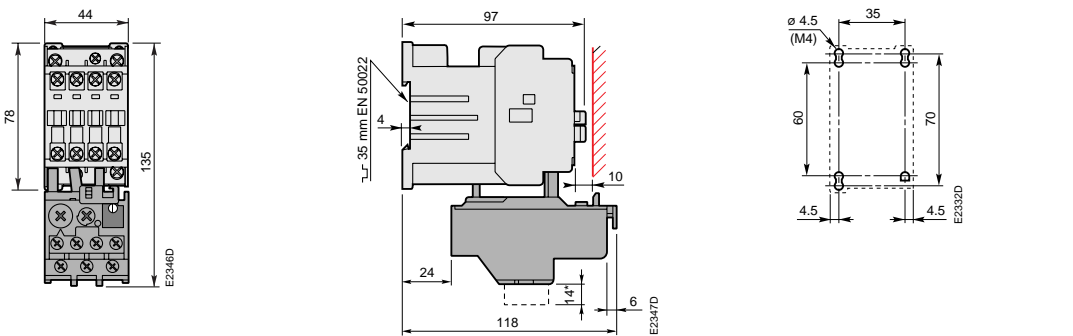

AL 9, AL 12, AL 16 - 3-pole
AL 9 Z, AL 12 Z, AL 16 Z - 3-pole
TAL 9, TAL 12, TAL 16 - 3-pole
+ TA 25 DU thermal O/L relay

* For TA 25 DU 32 only

AL 26, TAL 26 3 and 4-pole Contactors

Screw Terminals



Dimensions (in mm)

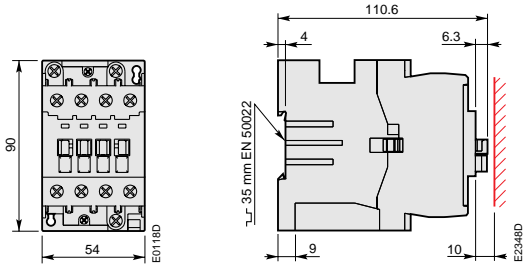

AL 26, TAL 26

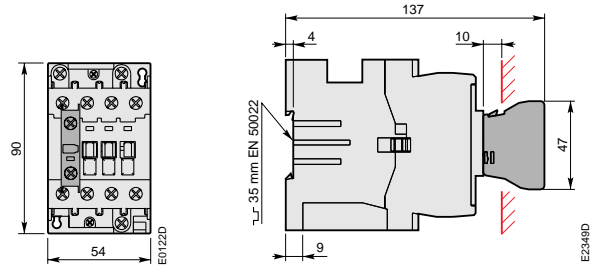

AL 26, TAL 26
+ CA 5 front-mounted 1-pole auxiliary contact block

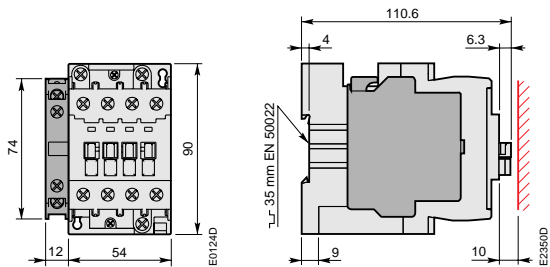

AL 26, TAL 26
+ CAL 5 side-mounted 2-pole auxiliary contact block

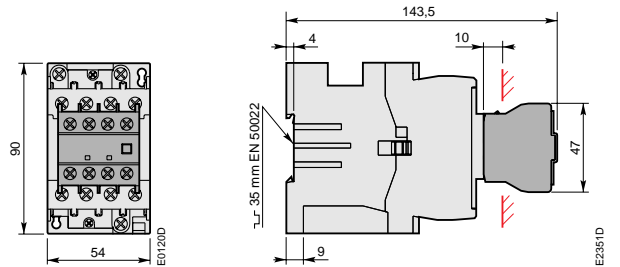

AL 26, TAL 26
+ CA 5 front-mounted 4-pole auxiliary contact block

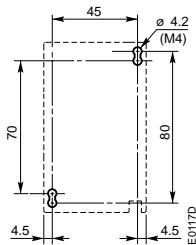

AL 26, TAL 26 - drilling plan

AL 26, TAL 26 3 and 4-pole Contactors

Screw Terminals



Dimensions (in mm)

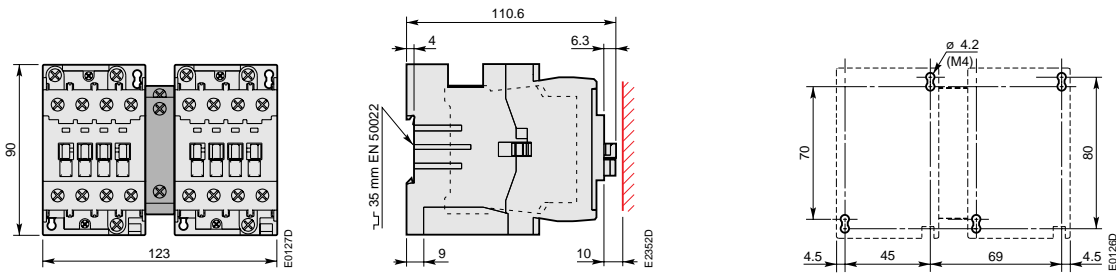

AL 26, TAL 26 + VE 5-1 electrical and mechanical interlock unit

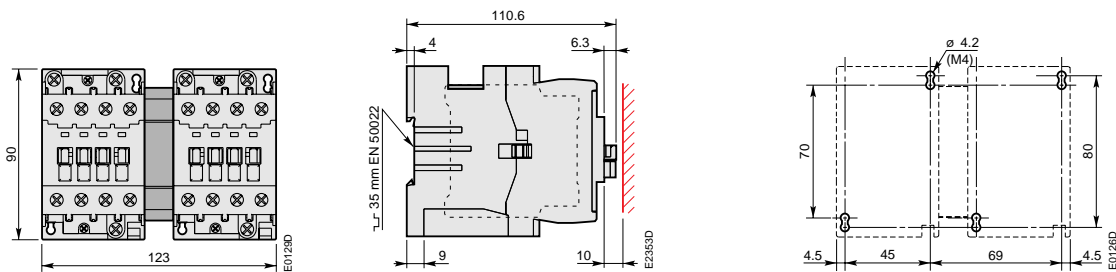

AL 26, TAL 26 + VM 5-1 mechanical interlock unit

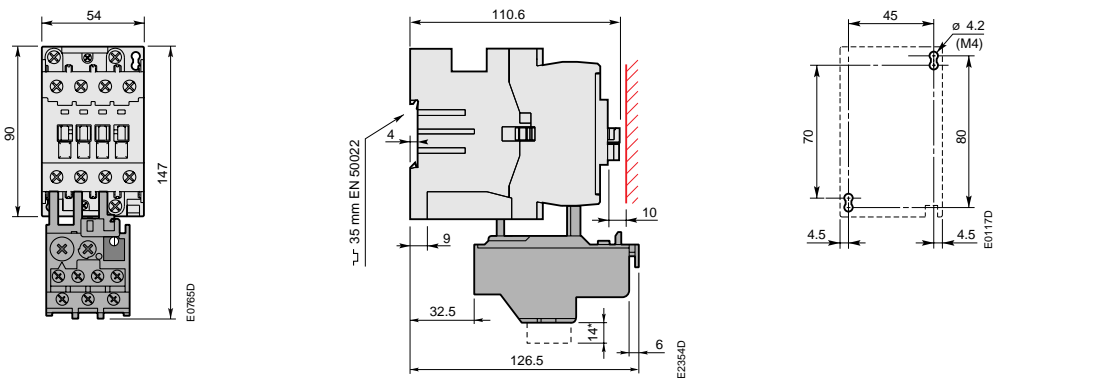

AL 26, TAL 26 - 3-pole + TA 25 DU thermal O/L relay

* For TA 25 DU 32 only

AL 30, AL 40, TAL 30, TAL 40 3-pole Contactors



Screw Terminals

Dimensions (in mm)

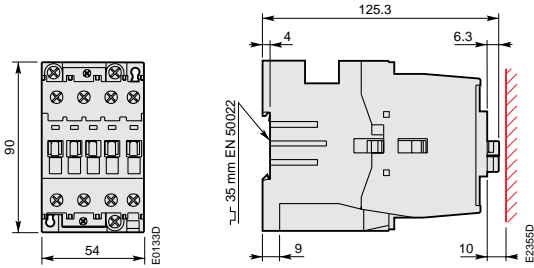

AL 30, AL 40, TAL 30, TAL 40

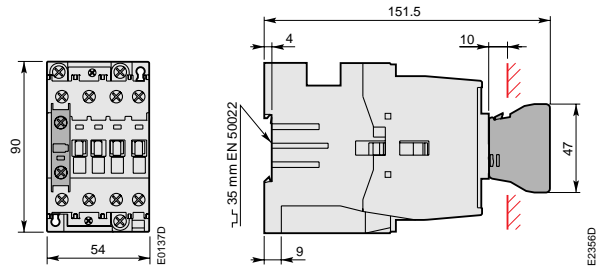

AL 30, AL 40, TAL 30, TAL 40
+ CA 5 front-mounted 1-pole auxiliary contact block

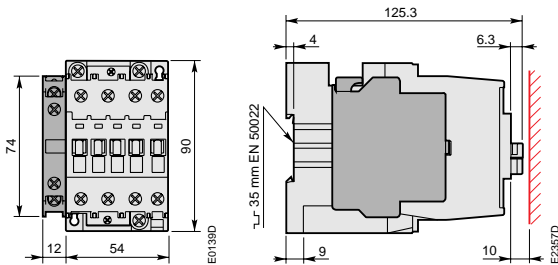

AL 30, AL 40, TAL 30, TAL 40
+ CAL 5 side-mounted 2-pole auxiliary contact block

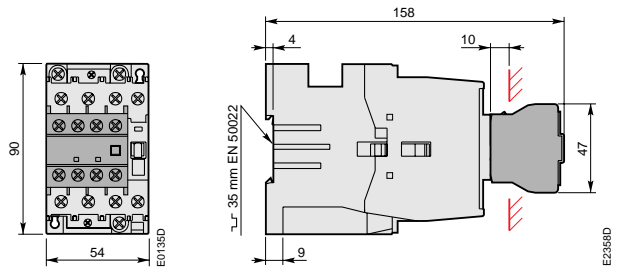

AL 30, AL 40, TAL 30, TAL 40
+ CA 5 front-mounted 4-pole auxiliary contact block

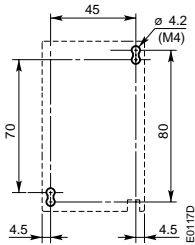

AL 30, AL 40, TAL 30, TAL 40 - drilling plan

AL 30, AL 40, TAL 30, TAL 40 3-pole Contactors



Screw Terminals

Dimensions (in mm)

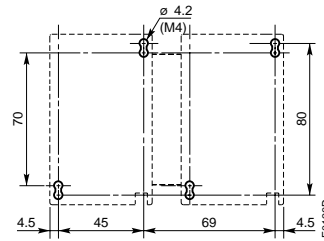
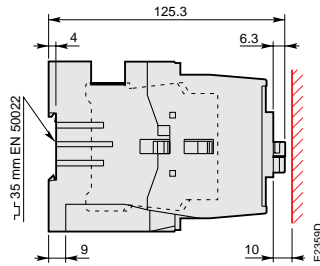
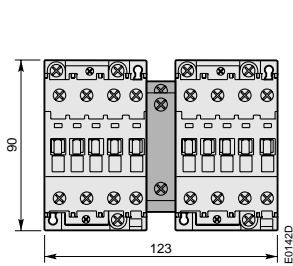

AL 30, AL 40, TAL 30, TAL 40 + VE 5-1 electrical and mechanical interlock unit

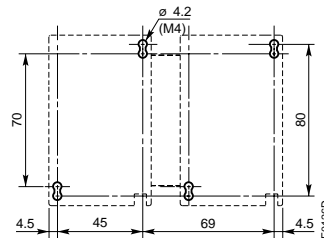
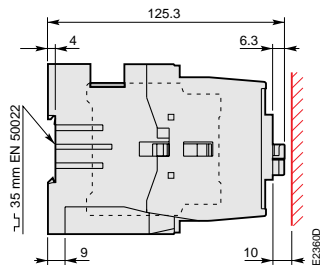
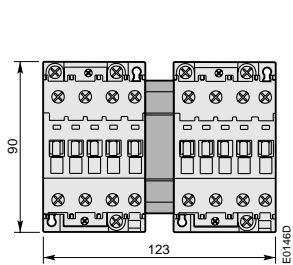

AL 30, AL 40, TAL 30, TAL 40 + VM 5-1 mechanical interlock unit

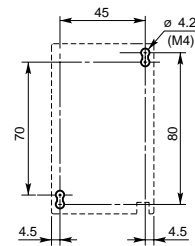
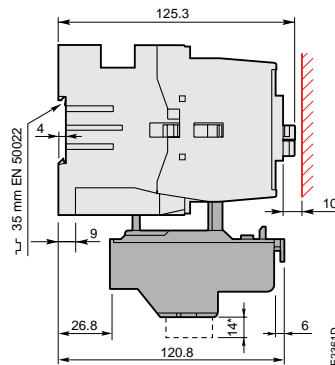
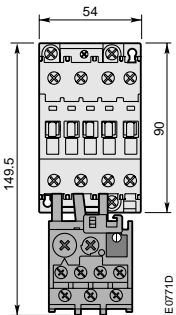

AL 30, AL 40, TAL 30, TAL 40 + TA 25 DU thermal O/L relay

* For TA 25 DU 32 only

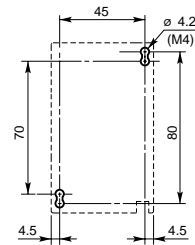
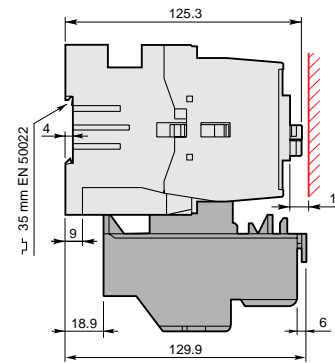
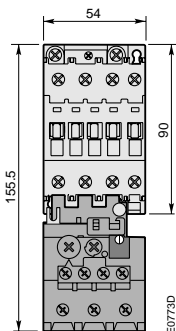

AL 30, AL 40, TAL 30, TAL 40 + TA 42 DU thermal O/L relay

AL..ST, AL..Z..ST 3-pole Contactors NL..ST, NL..Z..ST Contactor Relays

Spring Terminals 



Dimensions (in mm)

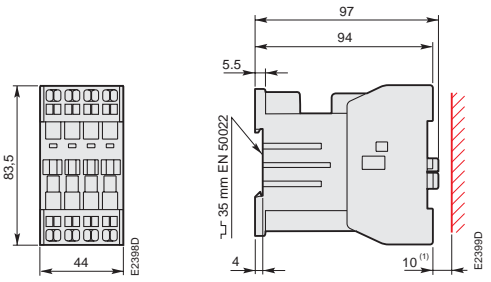

**AL..ST, AL..Z..ST
NL..ST, NL..Z..ST**

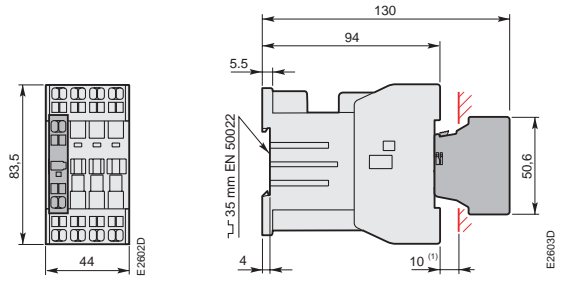

**AL..ST, AL..Z..ST
NL..ST, NL..Z..ST
+ CA 5-..ST front-mounted 1-pole auxiliary contact block**

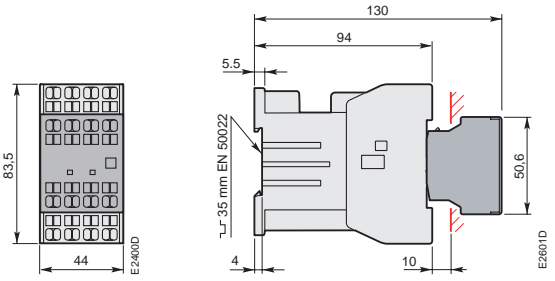

**AL..ST
NL..ST
+ CA 5-..ST front-mounted 4-pole auxiliary contact block**

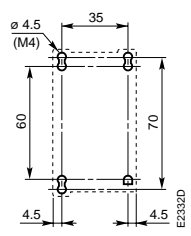

**AL..ST, AL..Z..ST
NL..ST, NL..Z..ST
drilling plan**

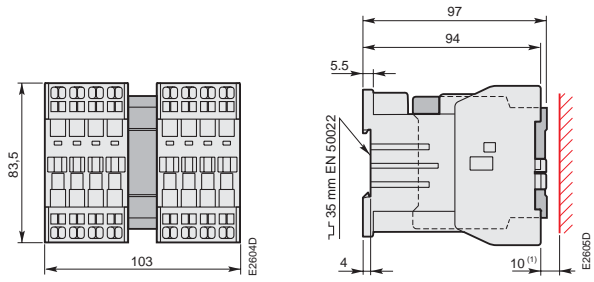

**AL..ST
+ VM 5-1 mechanical interlock unit**

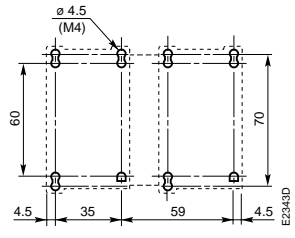

drilling plan

(1) Note: No recommended distance to earth is applicable to * NL..ST* contactor relays.

Contents

Industrial^{IT}

Industrial^{IT} Enabled Products

Control^{IT} Low Voltage Products



Industrial^{IT}

As a key element of its business strategy, ABB has committed to a broad program of product development and positioning under the Industrial^{IT} umbrella.

The **Industrial^{IT} Enabled Products** will provide all the relevant information like product identification, documentation, certificates and product data in electronic form in the engineering and work environment.

The **Industrial^{IT} Enabled Products** provide for this purpose all the data you need to do the right selection. Standardized product identification by type designator, identity number and international article number (EAN-code) insure that the right product is handled and delivered. Documentation on-line is available.

Most of the Low Voltage Products have already been Industrial^{IT} enabled among **Control^{IT}** Block Contactors, Mini Contactors and **Control^{IT}** Overload Relays and Electronic Overload Relays.

For further information, please consult the ABB Website

 www.abb.com/industrialit

Industrial^{IT}



ABB Entrelec

10, rue Ampère Z.I. - B.P. 114
F-69685 Chassieu cedex / France
Telephone: +33 (0) 4 7222 1722
Telefax: +33 (0) 4 7222 1935
<http://www.abb.com/lowvoltage>

As part of its on-going product improvement, ABB reserves the right to modify the characteristics or the products described in this document. The information given is not-contractual. For further details please contact the ABB company marketing these products in your country.

Publication
No: T5BC 101139 C0201
Printed in France (W+X 09.03 CH)